

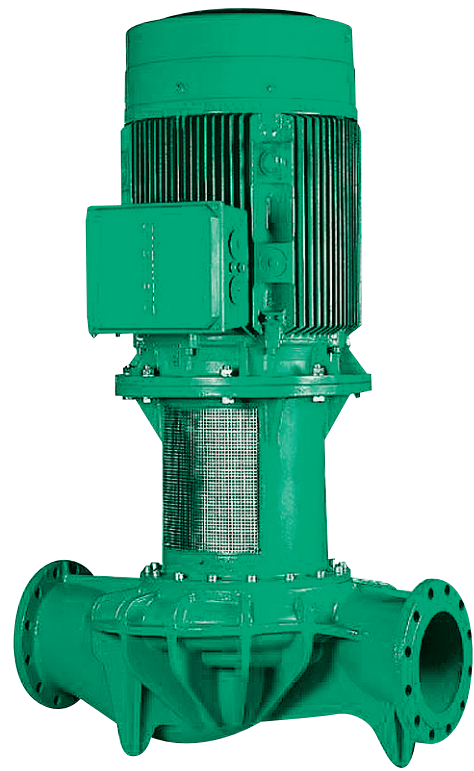

## In-Line Pumps

■ IL .....	2
■ PIL .....	21
■ PIN .....	31





# In-Line Pumps

## IL Series

### Product Introduction



### Wilo - IL

New Range In-Line pump

### Model number

- E.g) IL 250/420-110/4
- IL : New Range In-Line pump
  - 250/ : bores for suction/discharge side
  - 420 : nominal impeller outer diameter(mm)
  - 110/ : Motor rating (kW)
  - 4 : number of pole (4 pole motor)

### Features and strengths

- **Structure**
  - back pull out structure for easy maintenance of the mechanical seal and motor (IL250 Series)
  - Coupling connection
- **Casing**
  - In-Line pump casing that bores for suction and discharge side are the same
  - Use of external Rib ensures high safety even in high temperature above operating pressure (Big sized model)
- **Impeller**
  - Optimized design by 3D flow analysis
  - Minimizing friction to bring high efficiency
- **Motor**
  - Use of IEC standard motor to bring high compatibility
- **Mechanical seal**
  - Use of cartridge seal (IL 250 Series)
  - Use of standard mechanical seal

### Application

- Circulation of cold/hot water in the building
- Circulation of hot water in townhouses
- Circulation of hot water
- Cooling tower
- Pressurizing, condensed water system

### Technical information

- **Applicable fluids**  
Hot water, cold water, coolant, glycol mixture(under 40%), heat exchanging water that meet VDI 2035
- **Working range**  
Max. flow rate : 850 m<sup>3</sup>/h  
Max. Head : 90m
- **Allowed working pressure**  
In case of 13bar, up to +140°C  
In case of 16bar, up to +120°C
- **Fluid Temperature**  
-20°C ~ +140°C
- **Ambient temperature**  
Max. +40°C
- **Sealing**  
Mechanical seal (for IL250, cartridge seal is used)
- **Flange**  
PN 16[EN 1092-2]  
1/8" Gauge tapping
- **Motor**  
IEC Standard motor  
3 phase, IP55, F
- **Materials**

Casing	Gray Cast Iron + Cataphoresis Coating
Impeller	Gray Cast Iron + Cataphoresis Coating
Shaft	Stainless steel
Lantern	Gray Cast Iron + Cataphoresis Coating
Mechanical Seal	AQ <sub>1</sub> EGG

# In-Line Pumps

## IL Series



### Performance curve 4pole

#### IL 32/170 Series

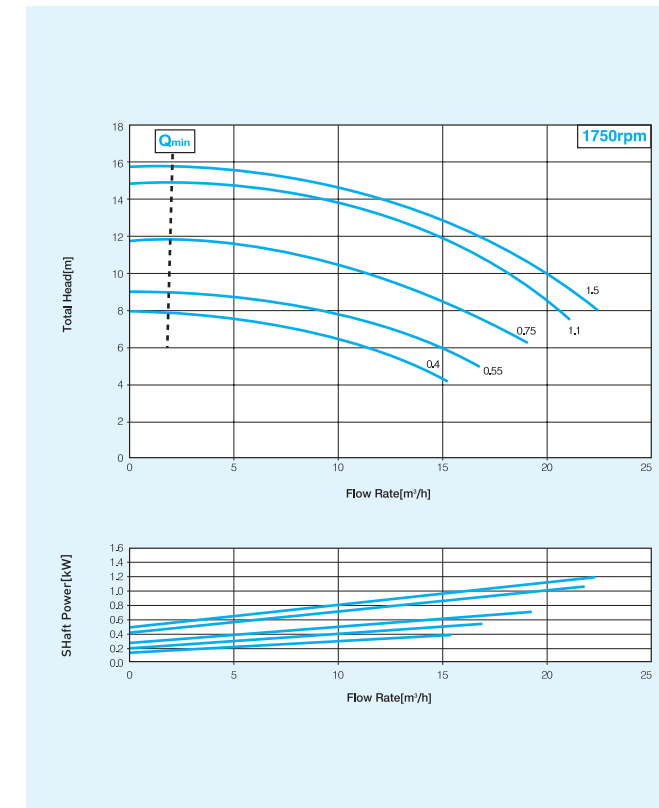

#### IL 40/170 Series

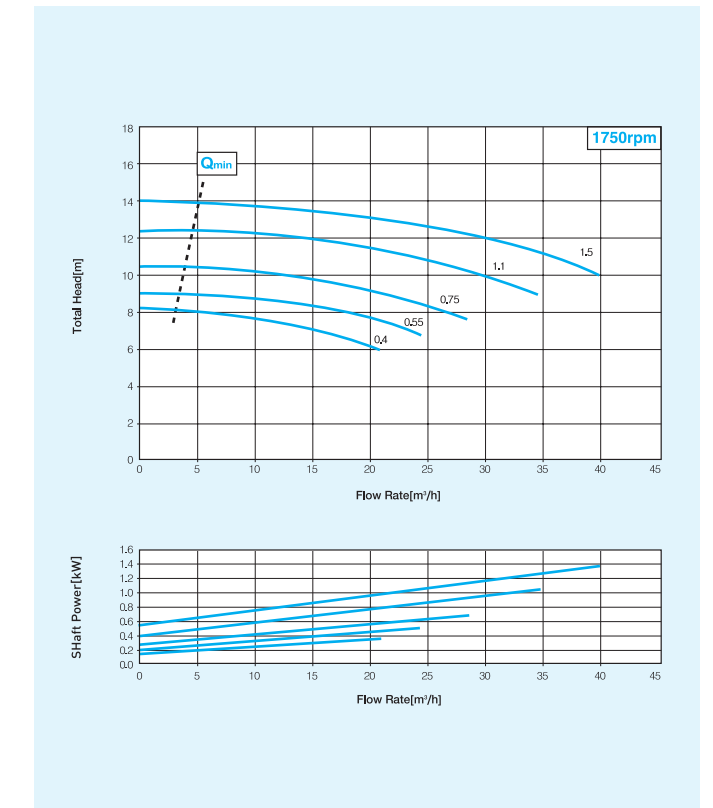

#### IL 40/220 Series

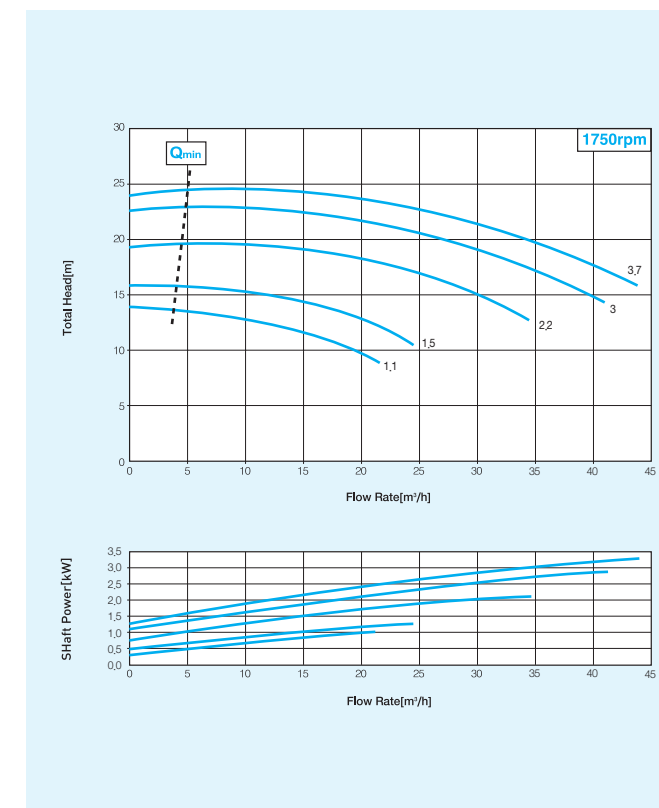

#### IL 50/170 Series

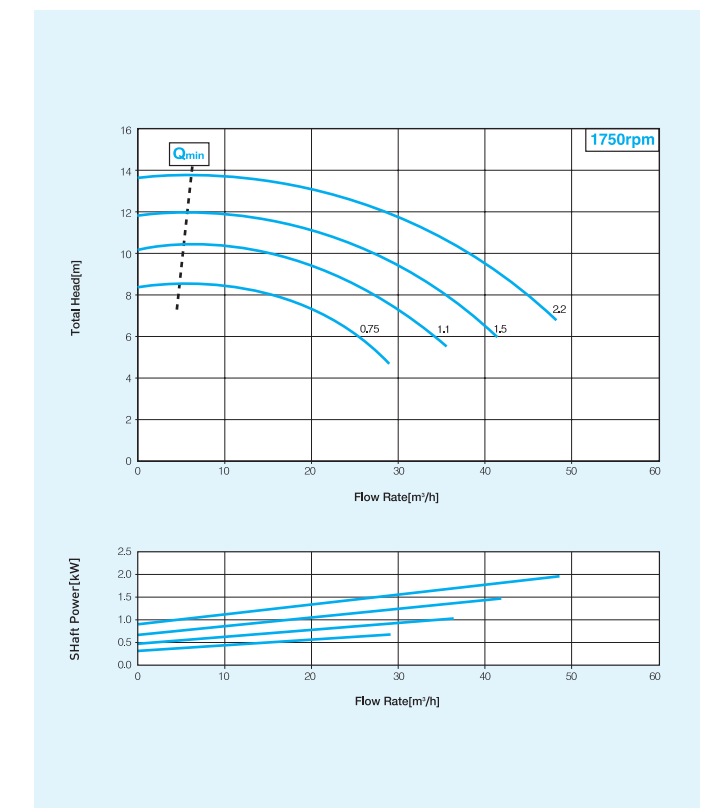



# In-Line Pumps

## IL Series

Performance curve 4pole

IL 50/220 Series

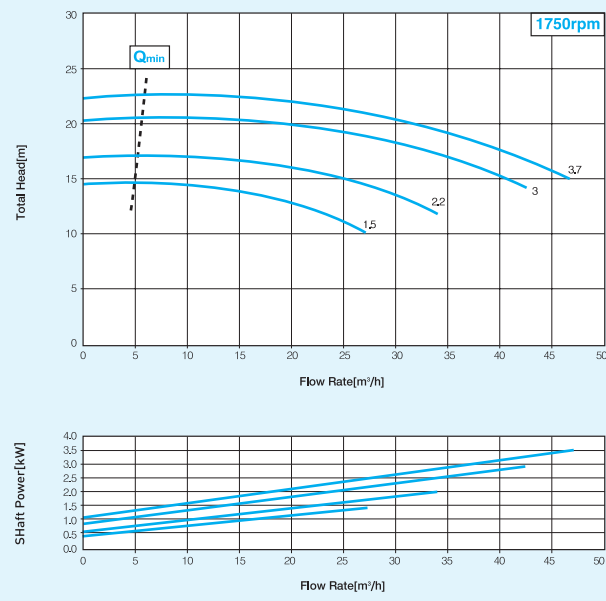

IL 50/270 Series

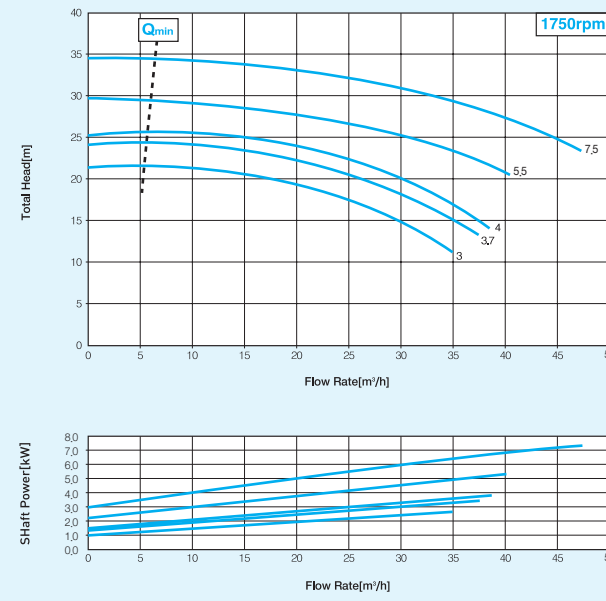

IL 65/170 Series

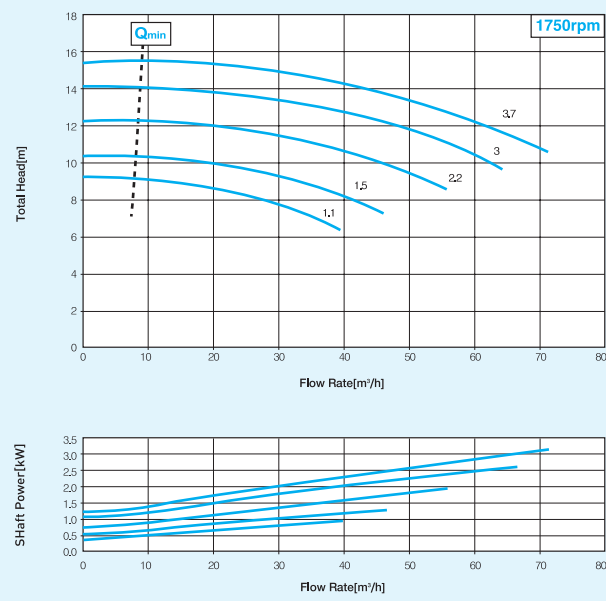

IL 65/220 Series

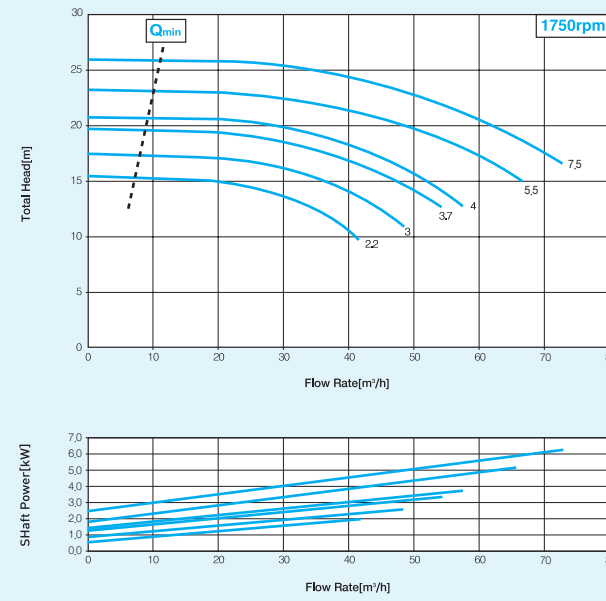

# In-Line Pumps

## IL Series



Performance curve 4pole

IL 65/270 Series

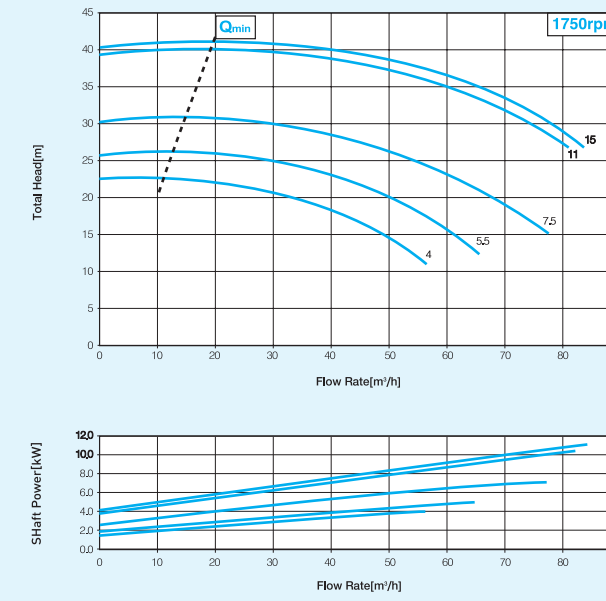

IL 80/170 Series

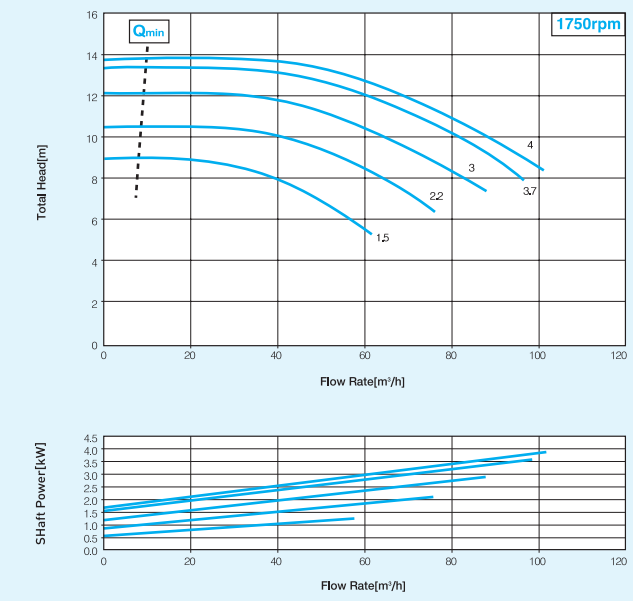

IL 80/220 Series

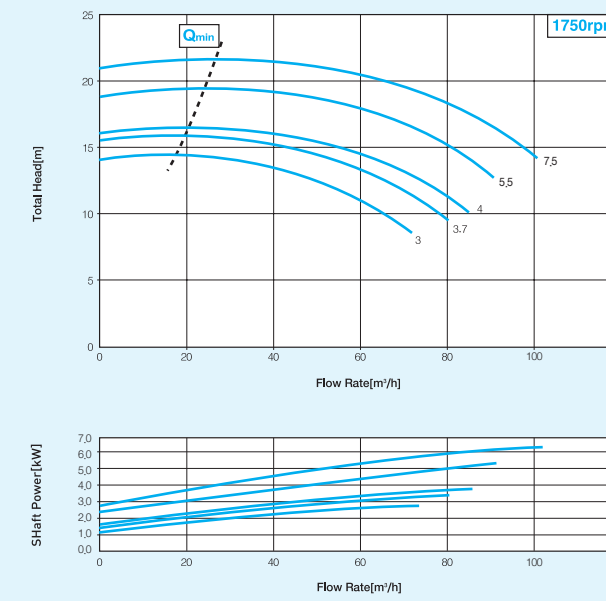

IL 80/270 Series

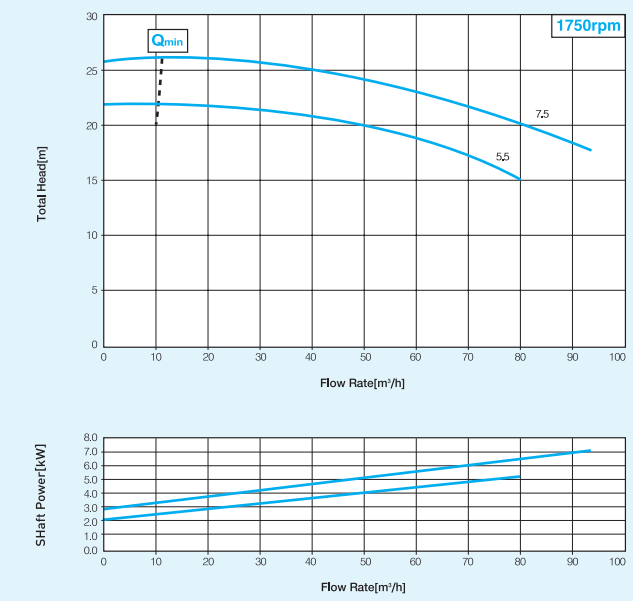



# In-Line Pumps

## IL Series

Performance curve 4pole

IL 100/170 Series

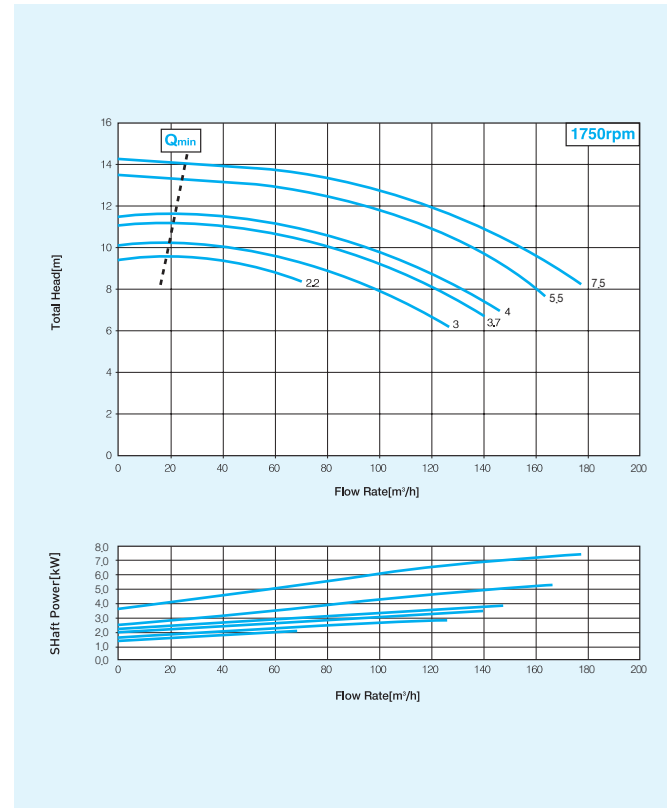

IL 100/220 Series

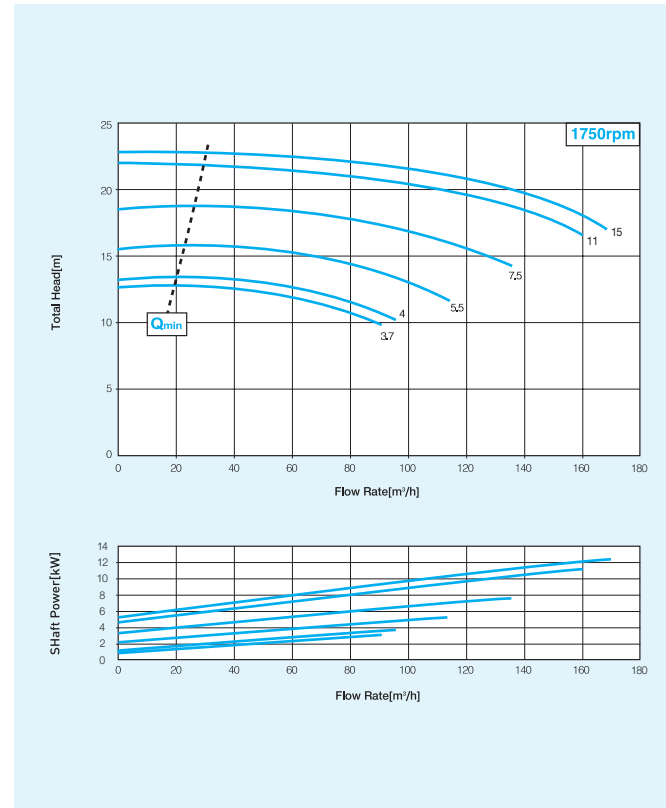

IL 100/270 Series

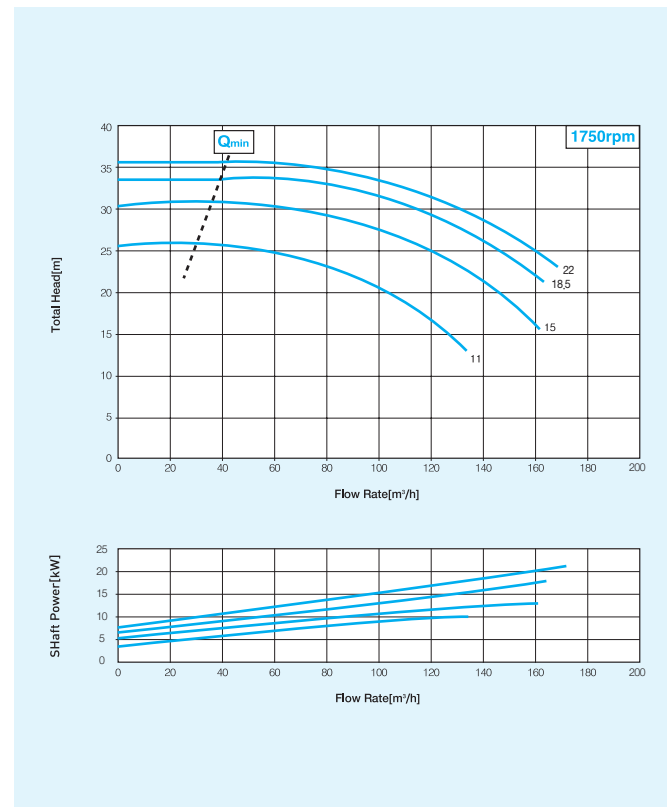

IL 125/220 Series

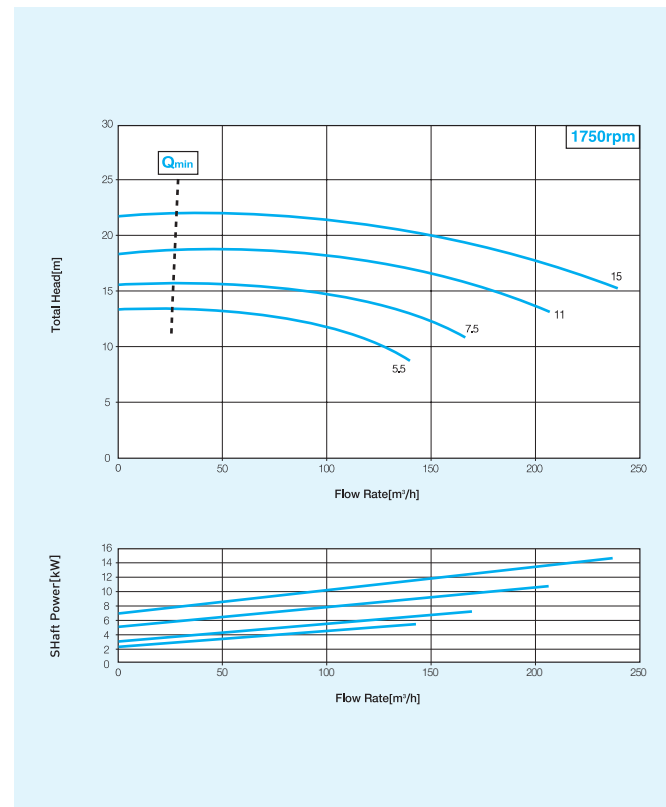

# In-Line Pumps

## IL Series



Performance curve 4pole

IL 125/270 Series

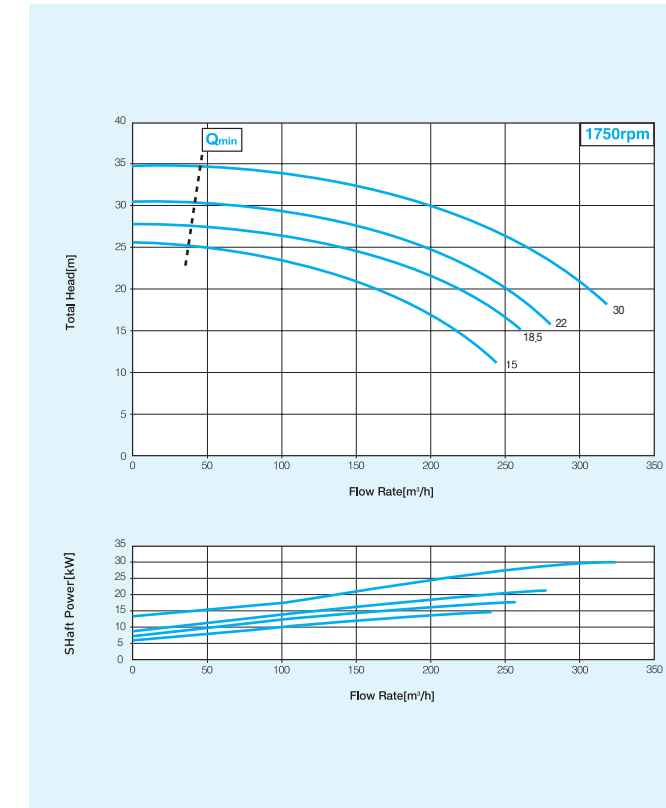

IL 125/340 Series

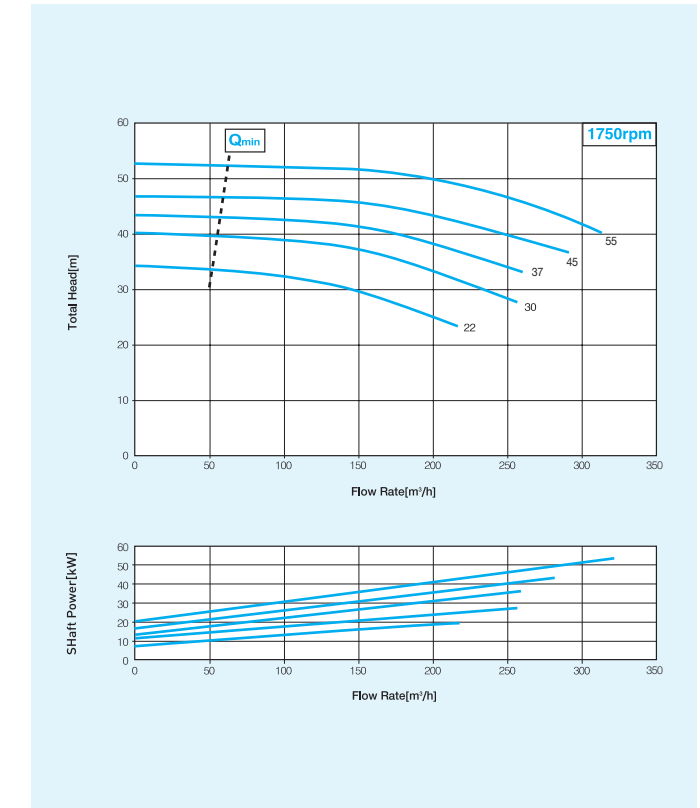

IL 150/220 Series

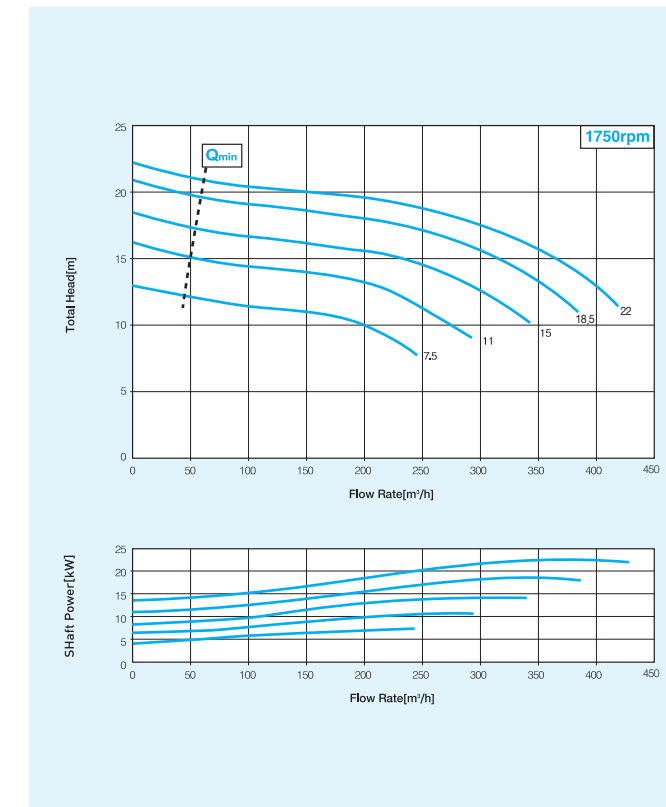

IL 150/270 Series

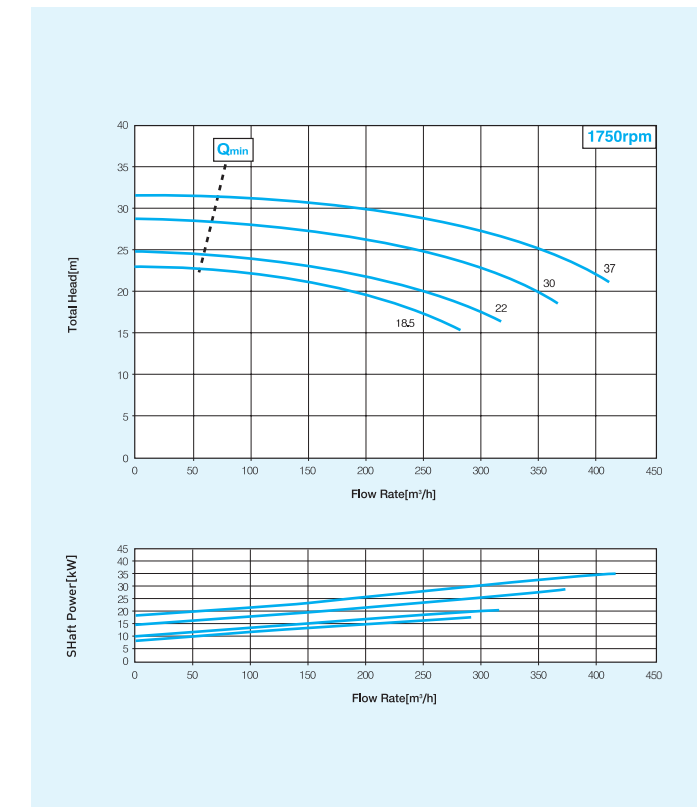



# In-Line Pumps

## IL Series

Performance curve 4pole

IL 150/340 Series

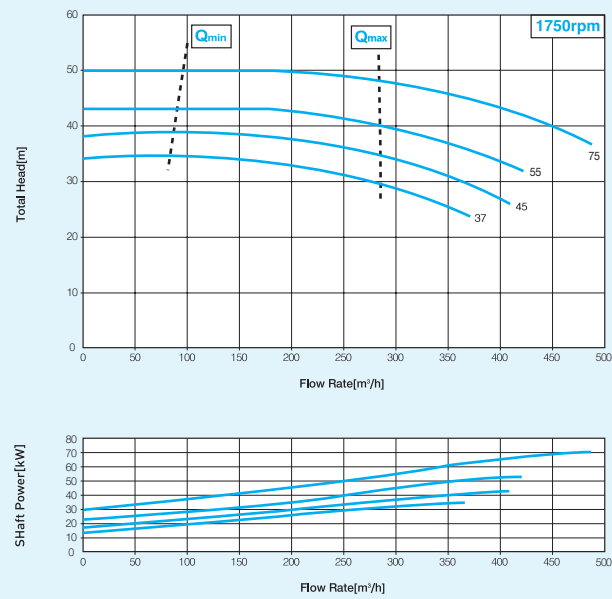

IL 200/270 Series

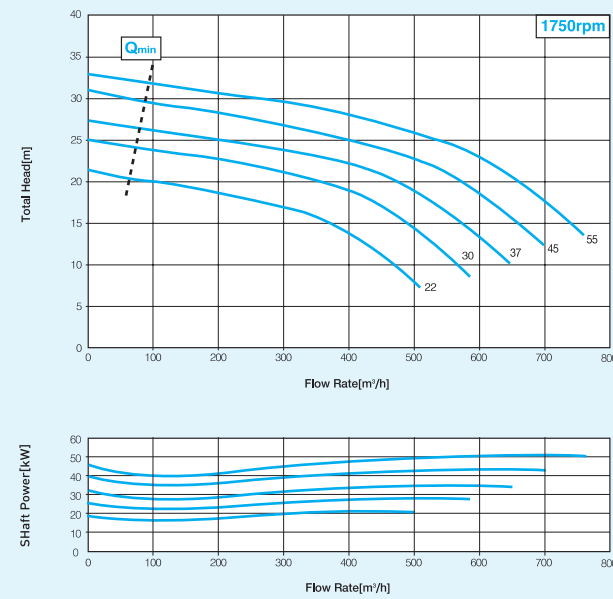

IL 200/340 Series

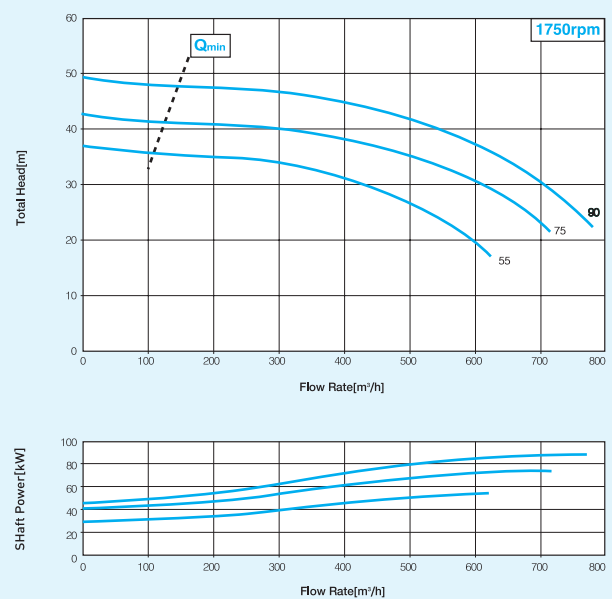

IL 250/420 Series

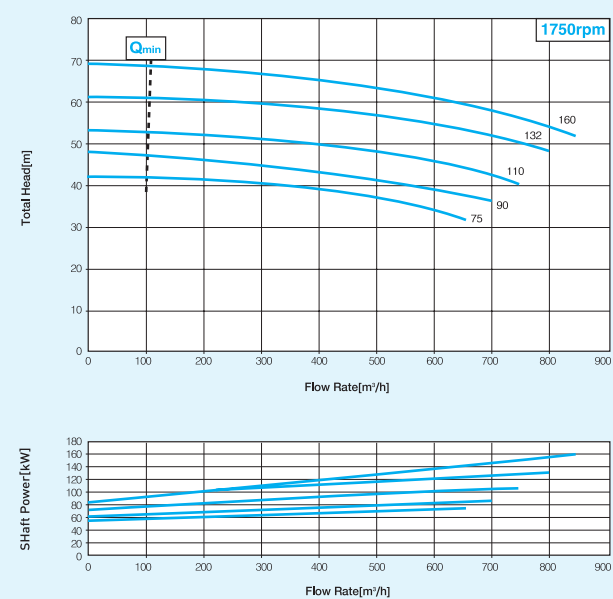

# In-Line Pumps

## IL Series

Performance curve 2pole



IL 32/170 Series

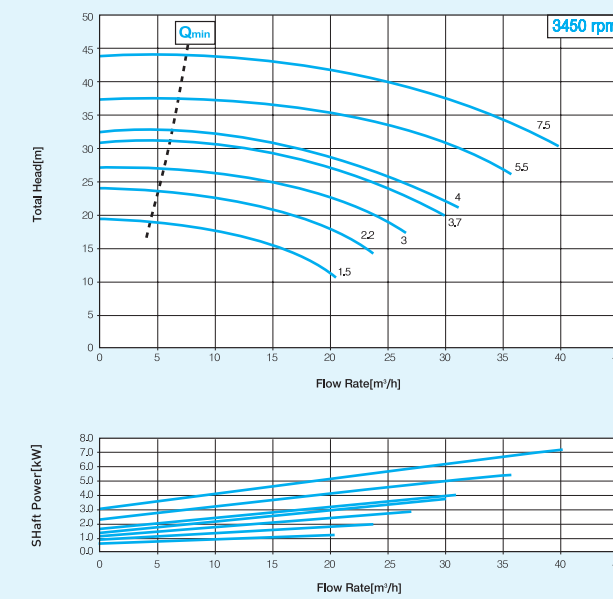

IL 40/170 Series

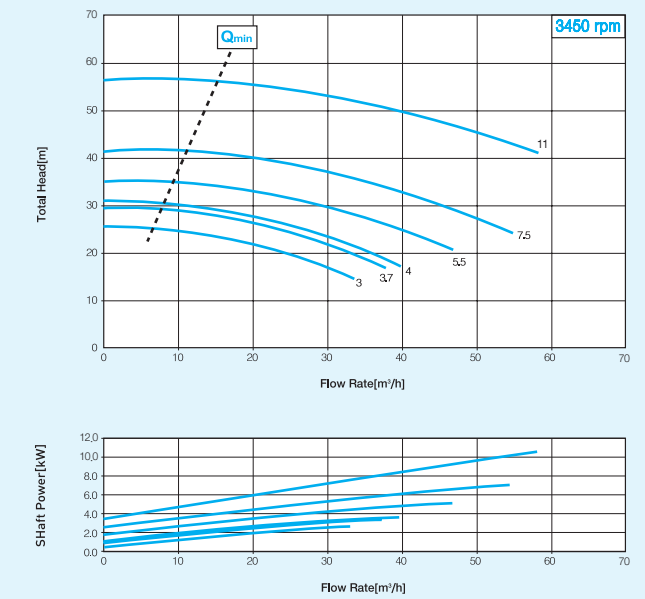

IL 40/220 Series

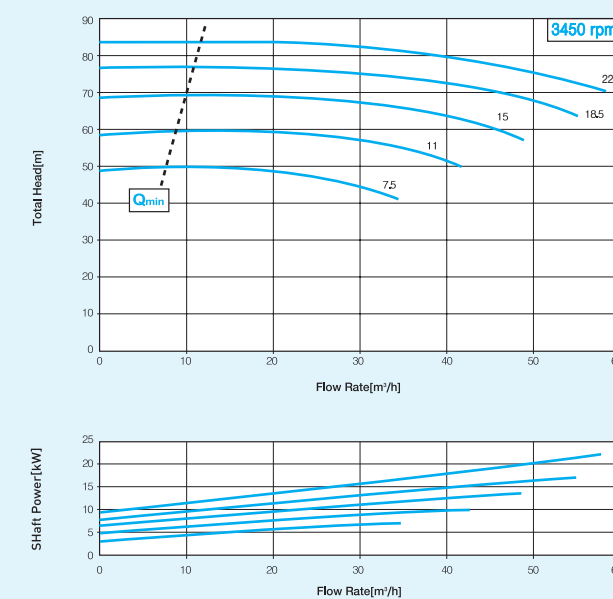

IL 50/140 Series

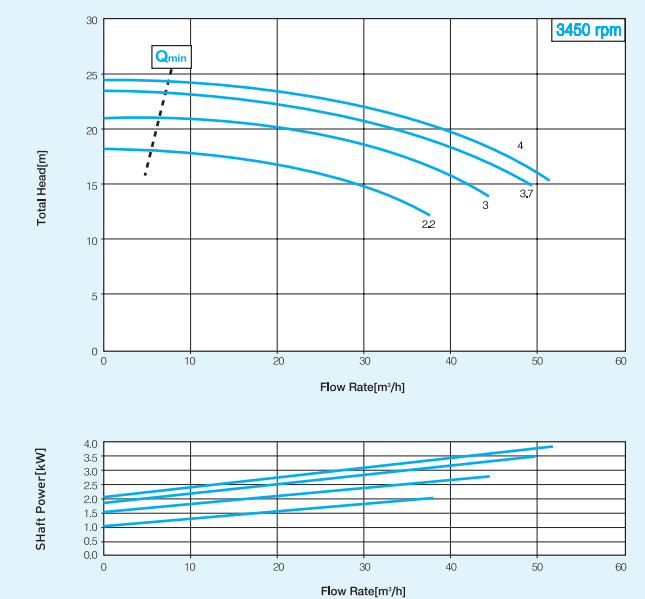



# In-Line Pumps

## IL Series

Performance curve 2pole

IL 50/170 Series

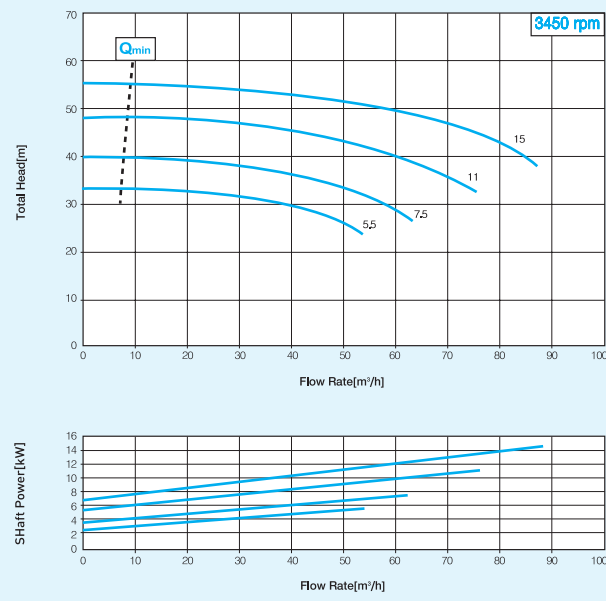

IL 50/220 Series

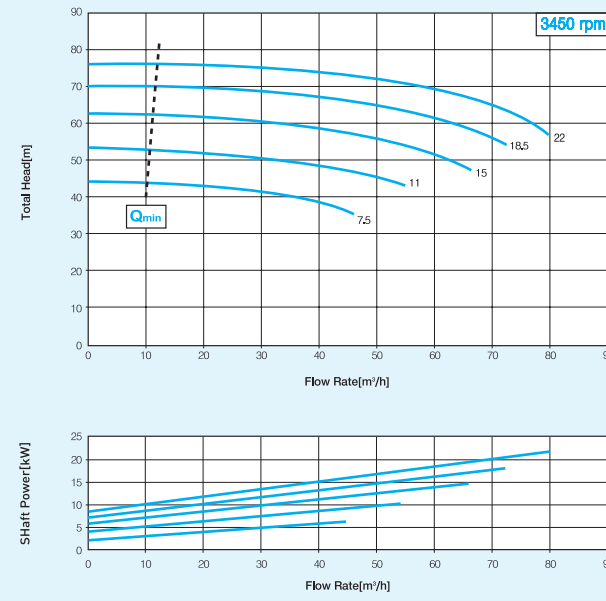

IL 65/140 Series

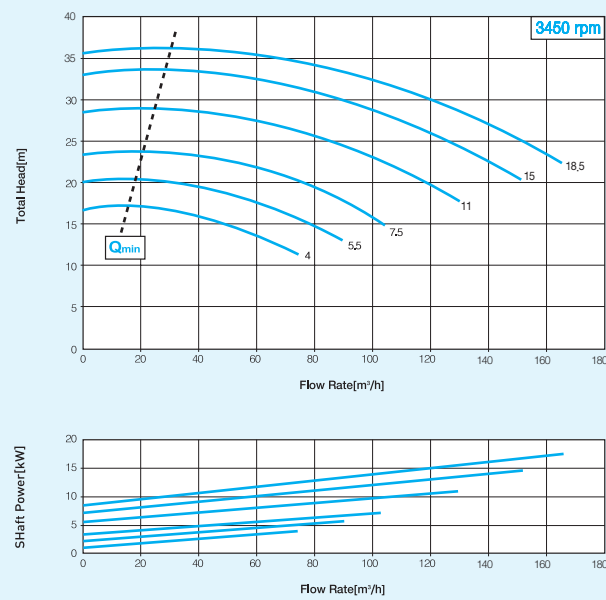

IL 65/170 Series

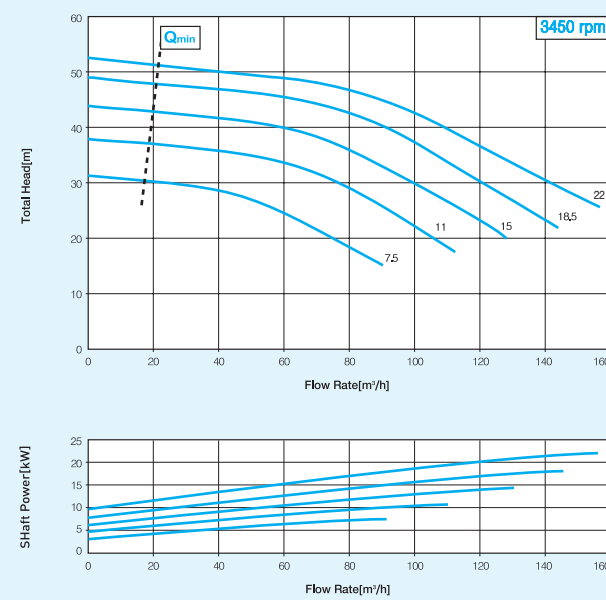

# In-Line Pumps

## IL Series

Performance curve 2pole



IL 65/220 Series

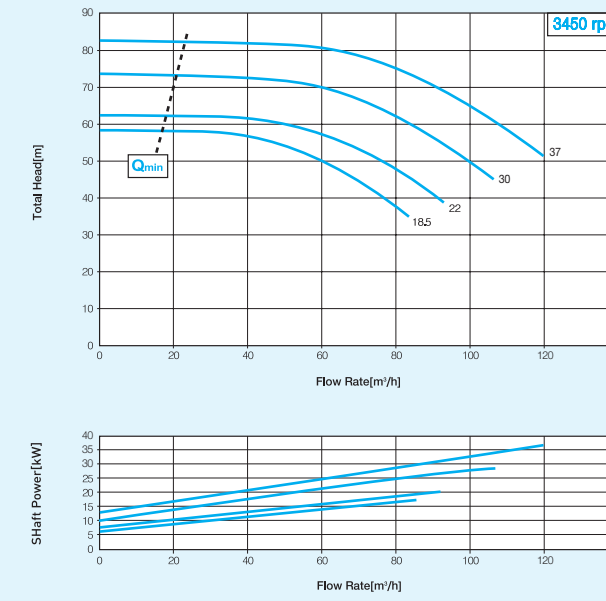

IL 80/140 Series

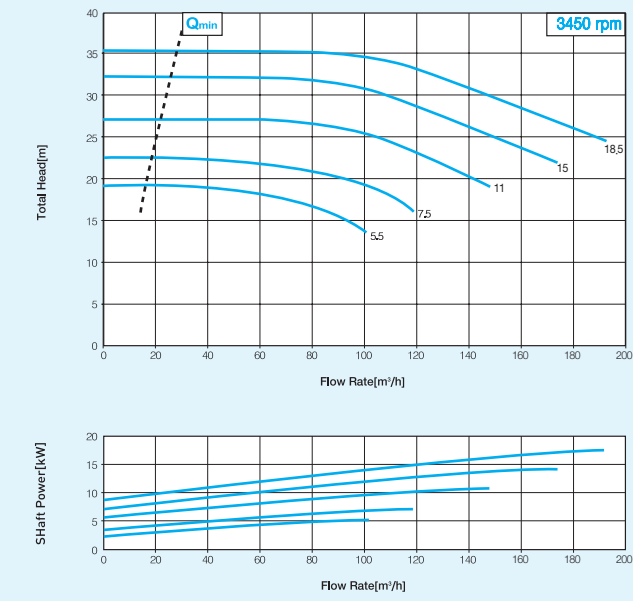

IL 80/170 Series

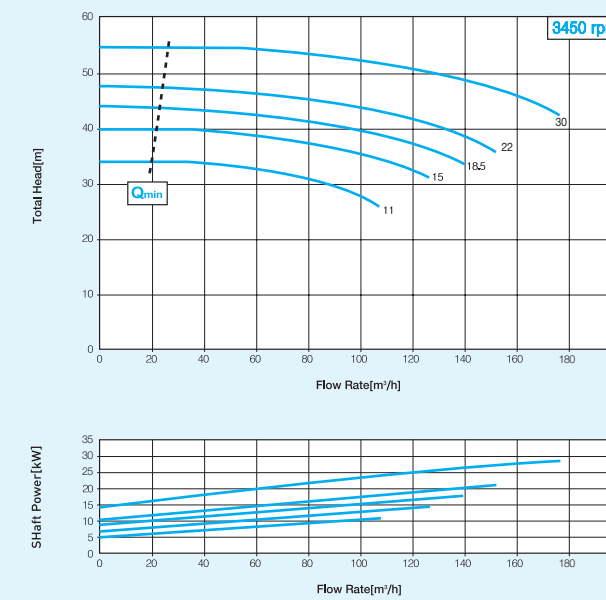

IL 80/220 Series

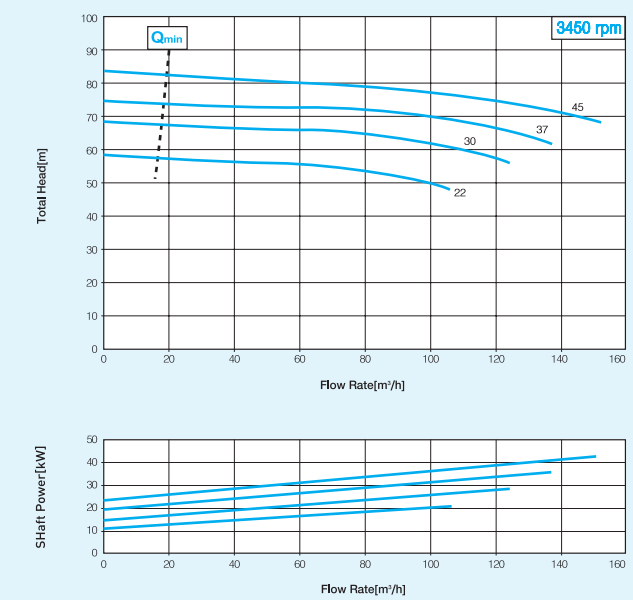



# In-Line Pumps

## IL Series

Performance curve 2pole

IL 100/170 Series

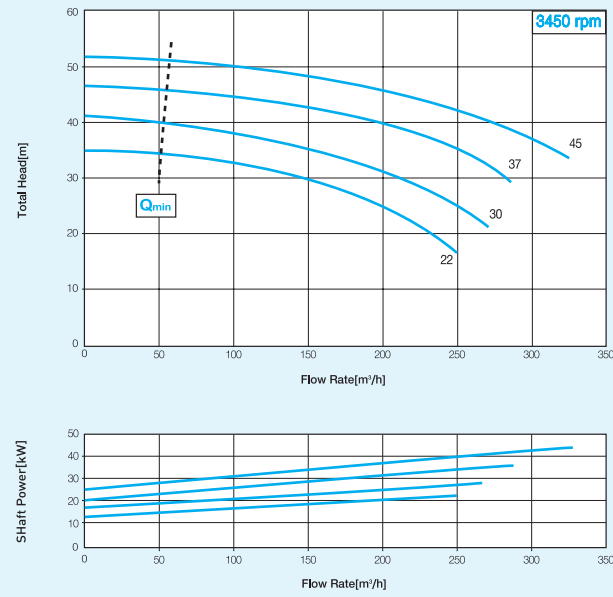

IL 100/220 Series

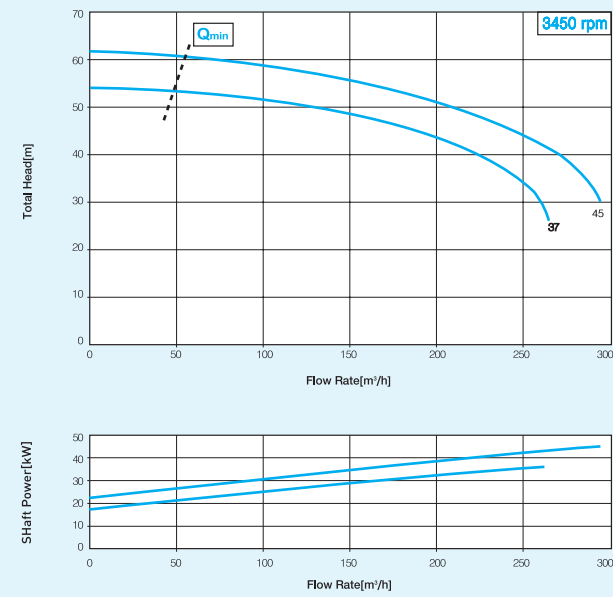

IL 32/170 Series

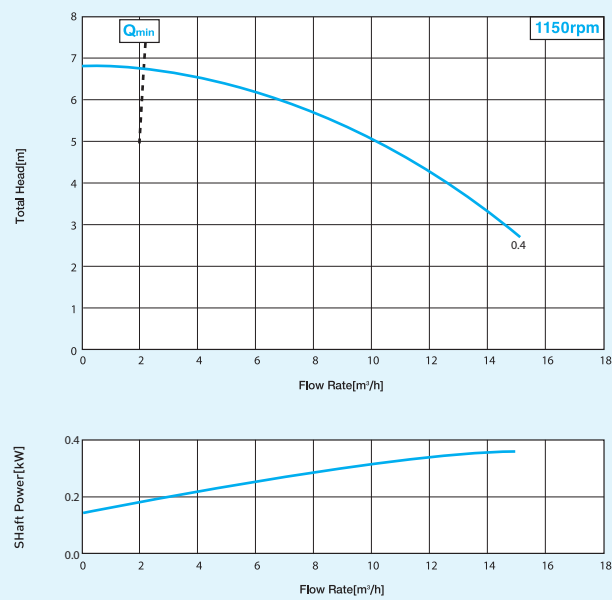

IL 40/170 Series

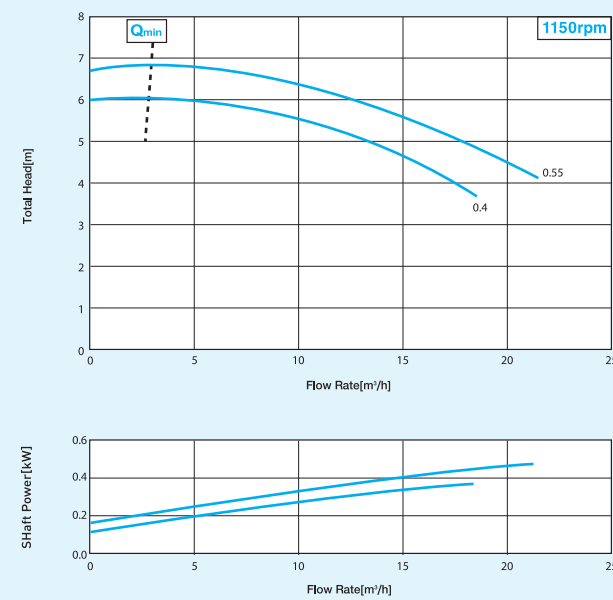

# In-Line Pumps

## IL Series

Performance curve 6pole



IL 50/170 Series

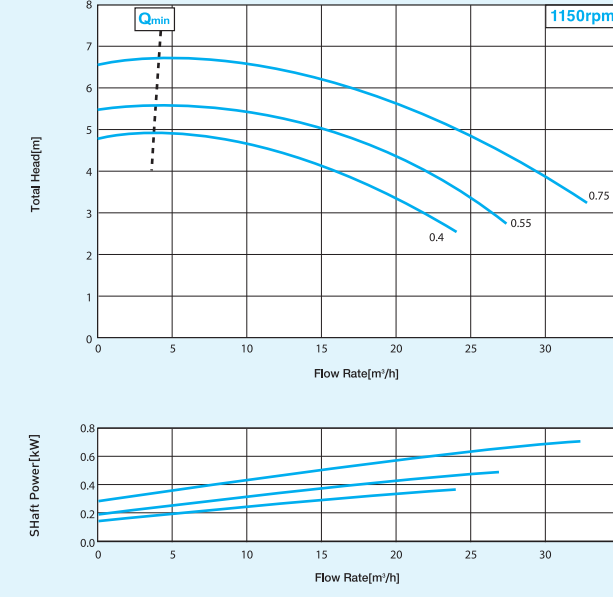

IL 65/170 Series

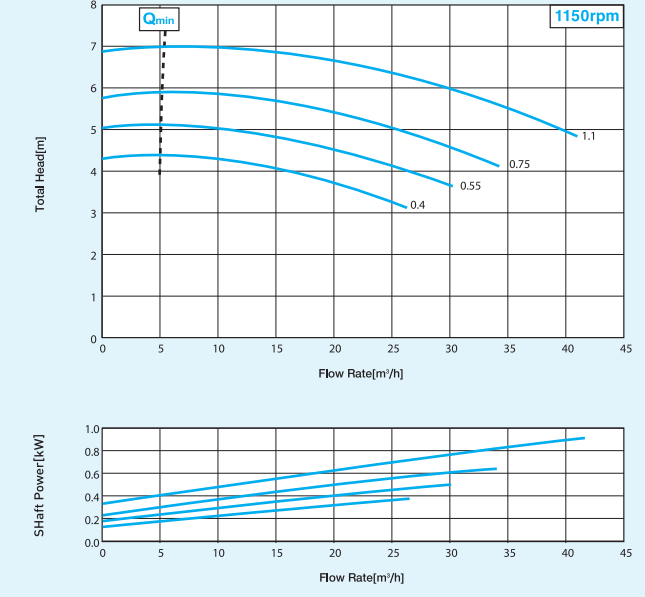

IL 80/170 Series

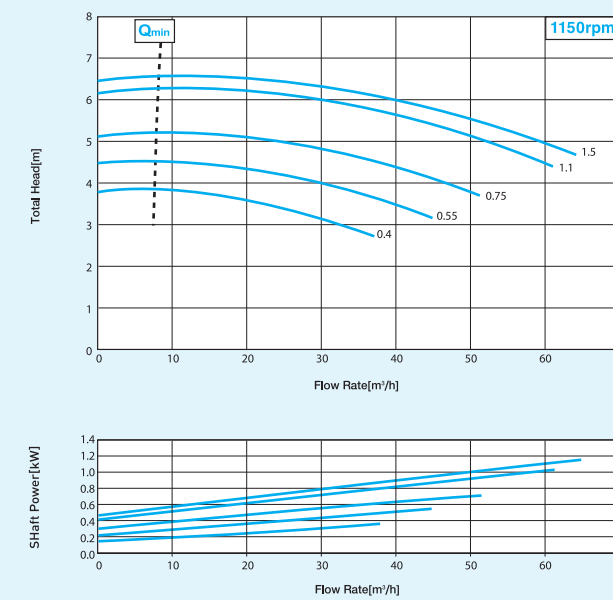

IL 100/170 Series

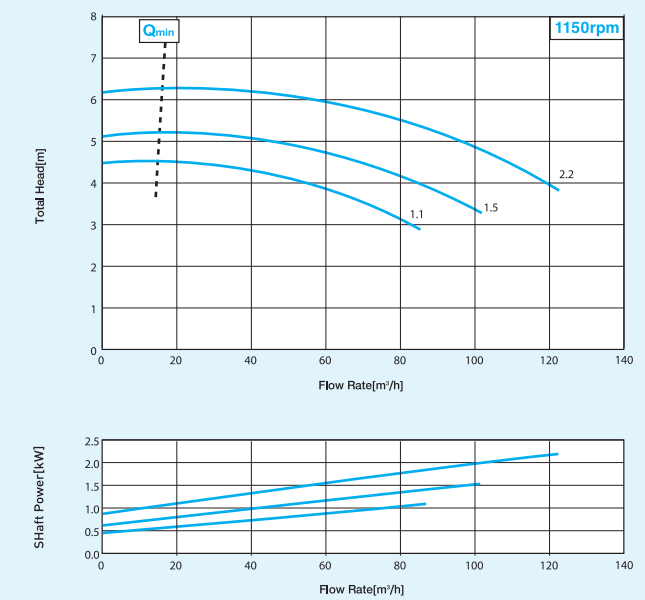



# In-Line Pumps

## IL Series

Performance curve 6pole

### IL 125/220 Series

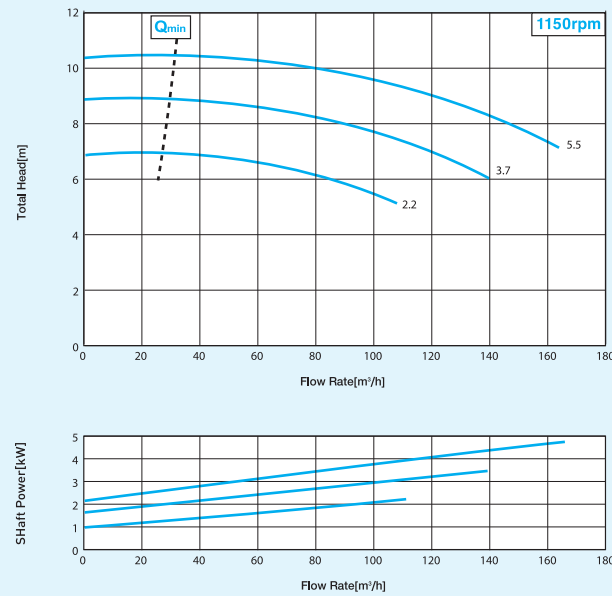

### IL 150/220 Series

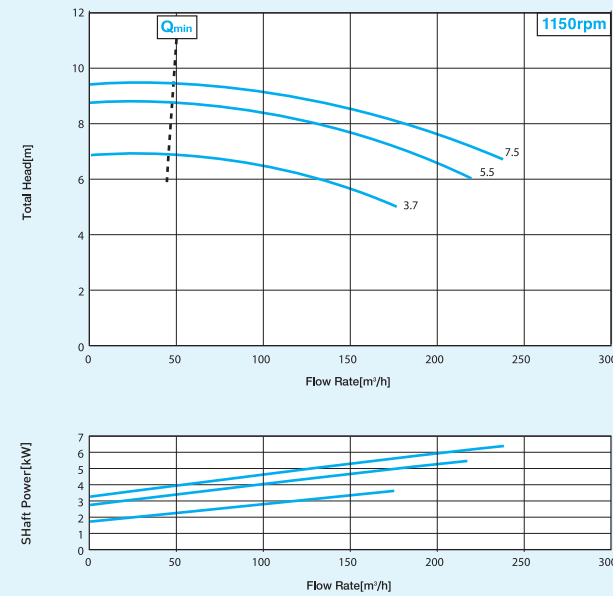

### IL 200/270 Series

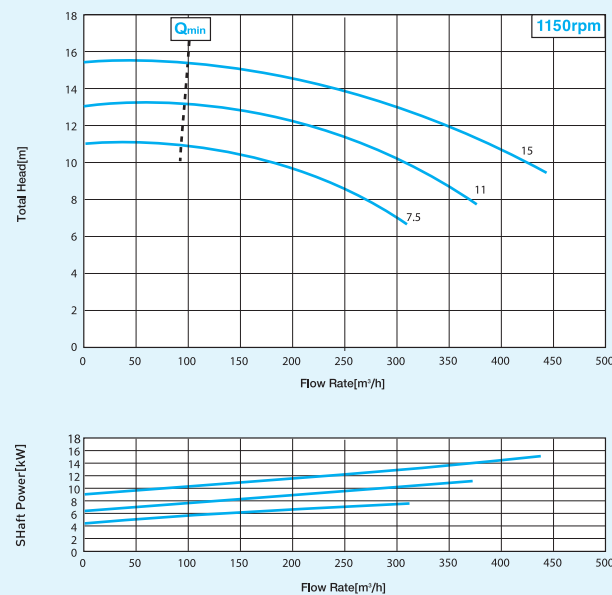

### IL 250/420 Series

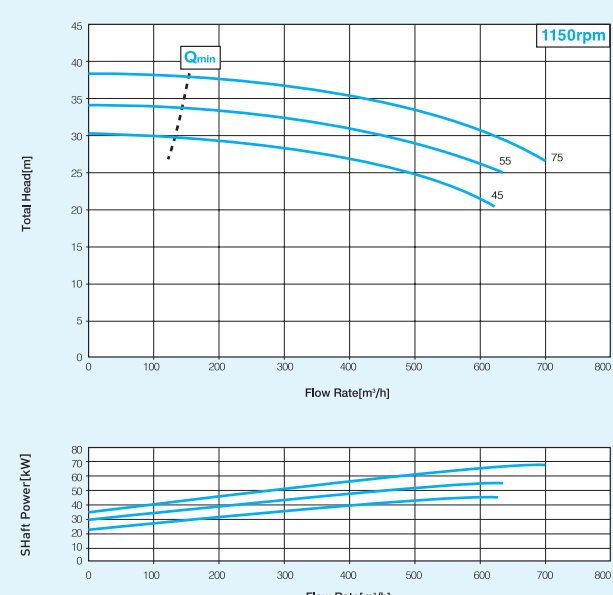

# In-Line Pumps

## IL Series

Outline Drawing & Dimension

### Outline Drawing

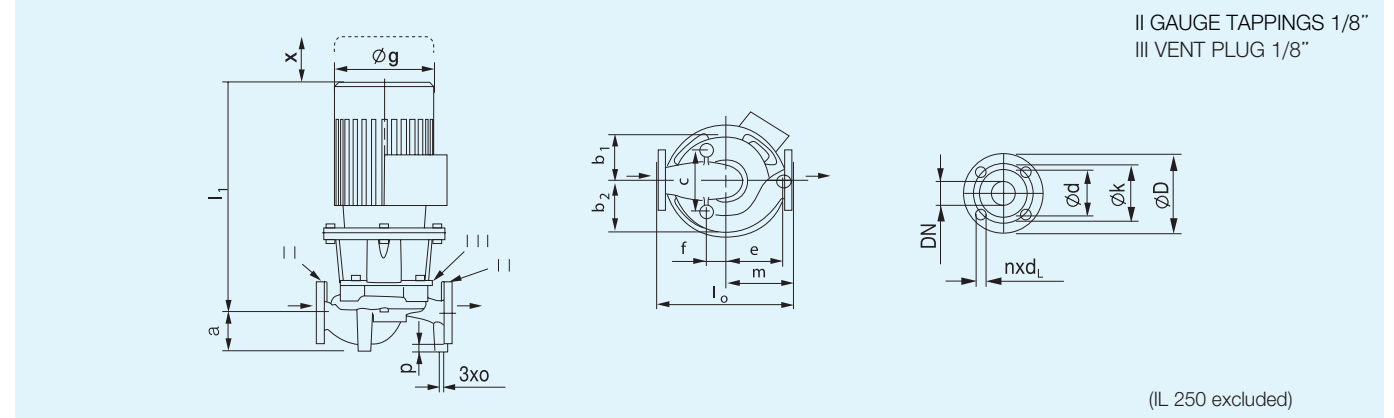

※ The Position of Terminal Box may be different for each model

### Installation

(IL 250 series)

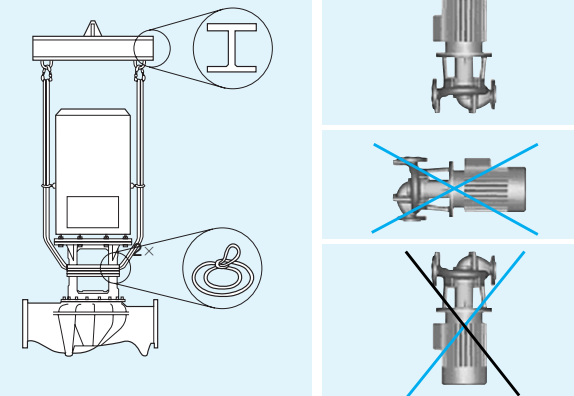

### Outline Drawing (IL 250 series)

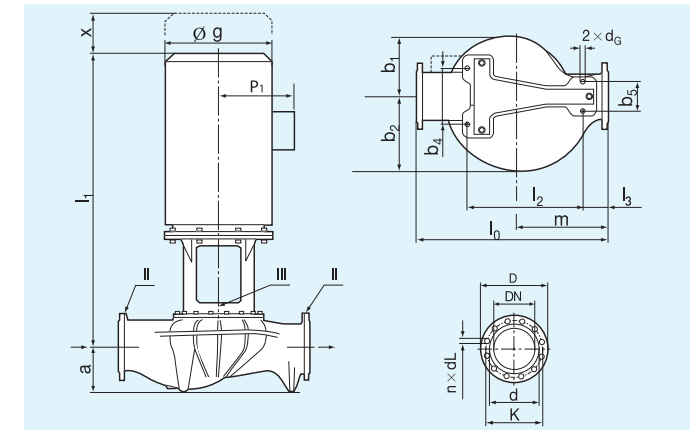

### IL 250 series Dimension & Motor Data

Model	DN	a	b <sub>1</sub>	b <sub>2</sub>	b <sub>4</sub>	b <sub>5</sub>	d <sub>G</sub>	Øg	mm				m	p1	x	Weight [kg]
									-l <sub>1max</sub>	l <sub>2</sub>	l <sub>3</sub>	l <sub>0</sub>				
IL250 / 420 -75 /4	250	321	369	454	340	180	24	514	1500	700	150	1150	557	440	190	1150
IL250 / 420 -90 /4	250	321	369	454	340	180	24	514	1600	700	150	1150	557	440	190	1200
IL250 / 420 -110 /4	250	321	369	454	340	180	24	600	1700	700	150	1150	557	528	190	1400
IL250 / 420 -132 /4	250	321	369	454	340	180	24	610	1870	700	150	1150	557	550	190	1450
IL250 / 420 -160 /4	250	321	369	454	340	180	24	656	1890	700	150	1150	557	565	190	1500
IL250 / 420 -45 /6	250	321	369	454	340	180	24	454	1345	700	150	1150	557	425	190	1050
IL250 / 420 -55 /6	250	321	369	454	340	180	24	514	1400	700	150	1150	557	440	190	1110
IL250 / 420 -75 /6	250	321	369	454	340	180	24	514	1400	700	150	1150	557	440	190	1120

### Flange Dimension

Pumphousing Flange EN 1092-2

DN	ØD	Ød	Øk	n x d <sub>L</sub>
	mm	mm	mm	Number x mm
32	140	76	100	4 x 19
40	150	84	110	4 x 19
50	165	99	125	4 x 19
65	185	118	145	4 x 19
80	200	132	160	8 x 19
100	220	156	180	8 x 19
125	250	188	210	8 x 19
150	285	211	240	8 x 23
200	340	266	295	12 x 23
250	405	319	355	12 x 28





# In-Line Pumps

## IL Series

Dimension 4pole

Model	DN	a	b <sub>1</sub>	b <sub>2</sub>	c	e	f	[mm]										Weight [kg]
								øg	l <sub>0</sub>	~l <sub>1</sub>	m	o	p	x				
IL32/170-0,4/4	32	100	112	124	120	132	68	132	320	418	155	M10	20	90	40			
IL32/170-0,55/4	32	100	112	124	120	132	68	175	320	436	155	M10	20	90	43			
IL32/170-0,75/4	32	100	112	124	120	132	68	175	320	436	155	M10	20	90	44			
IL32/170-1,1/4	32	100	112	124	120	132	68	193	320	502	155	M10	20	90	50			
IL32/170-1,5/4	32	100	112	124	120	132	68	193	320	502	155	M10	20	90	52			
IL40/170-0,4/4	40	82	113	129	130	149	58	132	340	432	170	M10	20	95	42			
IL40/170-0,55/4	40	82	113	129	130	149	58	175	340	450	170	M10	20	95	46			
IL40/170-0,75/4	40	82	113	129	130	149	58	175	340	450	170	M10	20	95	47			
IL40/170-1,1/4	40	82	113	129	130	149	58	193	340	516	170	M10	20	95	52			
IL40/170-1,5/4	40	82	113	129	130	149	58	193	340	516	170	M10	20	95	54			
IL40/220-1,1/4	40	110	145	149	180	172	78	193	440	510	190	M10	20	100	60			
IL40/220-1,5/4	40	110	145	149	180	172	78	193	440	510	190	M10	20	100	62			
IL40/220-2,2/4	40	110	145	149	180	172	78	236	440	573	190	M10	20	100	70			
IL40/220-3/4	40	110	145	149	180	172	78	236	440	573	190	M10	20	100	74			
IL40/220-3,7/4	40	110	145	149	180	172	78	236	440	573	190	M10	20	100	77			
IL50/170-0,75/4	50	103	120	139	164	143	48	175	340	522	170	M10	20	100	51			
IL50/170-1,1/4	50	103	120	139	164	143	48	193	340	522	170	M10	20	100	56			
IL50/170-1,5/4	50	103	120	139	164	143	48	193	340	522	170	M10	20	100	58			
IL50/170-2,2/4	50	103	120	139	164	143	48	236	340	587	170	M10	20	100	69			
IL50/220-1,5/4	50	120	145	150	160	170	70	193	440	511	190	M10	20	100	65			
IL50/220-2,2/4	50	120	145	150	160	170	70	236	440	574	190	M10	20	100	76			
IL50/220-3/4	50	120	145	150	160	170	70	236	440	574	190	M10	20	100	80			
IL50/220-3,7/4	50	120	145	150	160	170	70	236	440	574	190	M10	20	100	83			
IL50/270-3/4	50	122	174	178	200	200	70	236	440	576	220	M10	15	120	90			
IL50/270-3,7/4	50	122	174	178	200	200	70	236	440	576	220	M10	15	120	93			
IL50/270-4/4	50	122	174	178	200	200	70	236	440	576	220	M10	15	120	94			
IL50/270-5,5/4	50	122	174	178	200	200	70	274	440	631	220	M10	15	120	113			
IL50/270-7,5/4	50	122	174	178	200	200	70	274	440	631	220	M10	15	120	123			
IL65/170-1,1/4	65	110	127	147	180	195	60	193	430	528	215	M12	20	120	62			
IL65/170-1,5/4	65	110	127	147	180	195	60	193	430	528	215	M12	20	120	64			
IL65/170-2,2/4	65	110	127	147	180	195	60	236	430	593	215	M12	20	120	72			
IL65/170-3/4	65	110	127	147	180	195	60	236	430	593	215	M12	20	120	76			
IL65/170-3,7/4	65	110	127	147	180	195	60	236	430	593	215	M12	20	120	79			
IL65/220-2,2/4	65	130	150	168	200	225	50	236	475	584	245	M12	20	110	83			
IL65/220-3/4	65	130	150	168	200	225	50	236	475	584	245	M12	20	110	87			
IL65/220-3,7/4	65	130	150	168	200	225	50	236	475	584	245	M12	20	110	90			
IL65/220-4/4	65	130	150	168	200	225	50	236	475	584	245	M12	20	110	91			
IL65/220-5,5/4	65	130	150	168	200	225	50	274	475	659	245	M12	20	110	103			
IL65/220-7,5/4	65	130	150	168	200	225	50	274	475	659	245	M12	20	110	113			
IL65/270-4/4	65	140	174	187	200	215	80	236	475	584	235	M12	20	110	97			
IL65/270-5,5/4	65	140	174	187	200	215	80	274	475	660	235	M12	20	120	121			
IL65/270-7,5/4	65	140	174	187	200	215	80	274	475	660	235	M12	20	120	132			
IL65/270-11/4	65	140	174	187	200	215	80	317	475	752	235	M12	20	120	203			
IL65/270-15/4	65	140	174	187	200	215	80	317	475	796	235	M12	20	120	218			
IL80/170-1,5/4	80	120	136	162	180	173	72	193	440	526	200	M12	20	120	73			
IL80/170-2,2/4	80	120	136	162	180	173	72	236	440	589	200	M12	20	120	83			
IL80/170-3/4	80	120	136	162	180	173	72	236	440	589	200	M12	20	120	87			
IL80/170-3,7/4	80	120	136	162	180	173	72	236	440	589	200	M12	20	120	90			
IL80/170-4/4	80	120	136	162	180	173	72	236	440	589	200	M12	20	120	91			
IL80/220-3/4	80	145	157	182	220	208	62	236	500	591	230	M12	20	120	94			
IL80/220-3,7/4	80	145	157	182	220	208	62	236	500	591	230	M12	20	120	97			
IL80/220-4/4	80	145	157	182	220	208	62	236	500	591	230	M12	20	120	98			
IL80/220-5,5/4	80	145	157	182	220	208	62	274	500	666	230	M12	20	120	110			
IL80/220-7,5/4	80	145	157	182	220	208	62	274	500	666	230	M12	20	120	120			
IL80/270-5,5/4	80	125	180	202	240	223	102	274	500	667	245	M12	20	115	130			
IL80/270-7,5/4	80	125	180	202	240	223	102	274	500	667	245	M12	20	115	141			
IL100/170-2,2	100	120	158	196	200	226	60	236	500	623	250	M12	20	135	96			
IL100/170-3/4	100	120	158	196	200	226	60	236	500	623	250	M12	20	135	100			
IL100/170-3,7	100	120	158	196	200	226	60	236	500	623	250	M12	20	135	104			
IL100/170-4/4	100	120	158	196	200	226	60	236	500	623	250	M12	20	135	105			
IL100/170-5,5	100	120	158	196	200	226	60	274	500	690	250	M12	20	135	124			
IL100/170-7,5	100	120	158	196	200	226	60	274	500	690	250	M12	20	135	134			
IL100/220-3,7/4	100	155	173	202	220	231	99	236	550	601	255	M12	20	110	111			
IL100/220-4/4	100	155	173	202	220	231	99	236	550	601	255	M12	20	110	112			
IL100/220-5,5/4	100	155	173	202	220	231	99	274	550	677	255	M12	20	120	136			
IL100/220-7,5/4	100	155	173	202	220	231	99	274	550	677	255	M12	20	120	147			
IL100/220-11/4	100	155	173	202	220	231	99	317	550	769	255	M12	20	120	217			

# In-Line Pumps

## IL Series

Dimension 4pole

Model	DN	a	b <sub>1</sub>	b <sub>2</sub>	c	e	f	[mm]										Weight [kg]
								øg	l <sub>0</sub>	~l <sub>1</sub>	m	o	p	x				
IL100/220-15/4	100	155	173	202	220	231	99	317	550	813	255	M12	20	120	232			
IL100/270-11/4	100	180	188	214	240	236	114	317	550	768	260	M12	20	120	234			
IL100/270-15/4	100	180	188	214	240	236	114	317	550	812	260	M12	20	120	250			
IL100/270-18,5/4	100	180	188	214	240	236	114	365	550	849	260	M12	20	120	300			
IL100/270-22/4	100	180	188	214	240	236	114	365	550	849	260	M12	20	120	310			
IL125/220-5,5/4	125	175	177	212	280	266	54	274	620	689	292	M16	25	120	151			
IL125/220-7,5/4	125	175	177	212	280	266	54	274	620	689	292	M16	25	120	161			
IL125/220-11/4	125	175	177	212	280	266	54	317	620	781	292	M16	25	120	211			
IL125/220-15/4	125	175	177	212	280	266	54	317	620	825	292	M16	25	120	226			
IL125/270-15/4	125	200	232	264	250	254	125	317	620	825	280	M16	25	130	276			
IL125/270-18,5/4	125	200	232	264	250	254	125	365	620	861	280	M16	25	130	321			
IL125/270-22/4	125	200	232	264	250	254	125	365	620	861	280	M16	25	130	331			
IL125/270-30/4	125	200	232	264	250	254	125	365	620	966	280	M16	25	130	390			
IL125/340-22/4	125	185	238	270	280	315	140	365	700	887	340	M16	25	140	306			
IL125/340-30/4	125	185	238	270	280	315	140	365	700	913	340	M16	25	140	400			
IL125/340-37/4	125	185	238	270	280	315	140	384	700	1102	340	M16	25	140	469			
IL125/340-45/4	125																	



# In-Line Pumps

## IL Series

Dimension 2pole

Model	DN	a	b <sub>1</sub>	b <sub>2</sub>	c	e	f	øg	l <sub>0</sub>	~l <sub>1</sub>	m	o	p	x	Weight
															[kg]
[mm]															
IL32/170-1,5/2	32	100	112	124	120	132	68	193	320	468	155	M10	20	90	50
IL32/170-2,2/2	32	100	112	124	120	132	68	193	320	468	155	M10	20	90	53
IL32/170-3/2	32	100	112	124	120	132	68	193	320	484	155	M10	20	90	64
IL32/170-3,7/2	32	100	112	124	120	132	68	193	320	484	155	M10	20	90	66
IL32/170-4/2	32	100	112	124	120	132	68	193	320	484	155	M10	20	90	67
IL32/170-5,5/2	32	100	112	124	120	132	68	236	320	575	155	M10	20	90	80
IL32/170-7,5/2	32	100	112	124	120	132	68	236	320	575	155	M10	20	90	86
IL40/170-3/2	40	82	113	129	130	149	58	193	340	498	170	M10	20	95	67
IL40/170-3,7/2	40	82	113	129	130	149	58	193	340	498	170	M10	20	95	69
IL40/170-4/2	40	82	113	129	130	149	58	193	340	498	170	M10	20	95	70
IL40/170-5,5/2	40	82	113	129	130	149	58	236	340	589	170	M10	20	95	83
IL40/170-7,5/2	40	82	113	129	130	149	58	236	340	589	170	M10	20	95	88
IL40/170-11/2	40	82	113	129	130	149	58	274	340	709	170	M10	20	95	120
IL40/220-7,5/2	40	110	145	149	180	172	78	236	440	594	190	M10	20	100	100
IL40/220-11/2	40	110	145	149	180	172	78	274	440	705	190	M10	20	100	142
IL40/220-15/2	40	110	145	149	180	172	78	274	440	740	190	M10	20	100	194
IL40/220-18,5/2	40	110	145	149	180	172	78	317	440	784	190	M10	20	100	210
IL40/220-22/2	40	110	145	149	180	172	78	365	440	820	190	M10	20	100	240
IL50/140-2,2/2	50	105	102	119	140	130	40	193	340	471	150	M10	20	100	52
IL50/140-3/2	50	105	102	119	140	130	40	193	340	489	150	M10	20	100	65
IL50/140-3,7/2	50	105	102	119	140	130	40	193	340	489	150	M10	20	100	67
IL50/140-4/2	50	105	102	119	140	130	40	193	340	489	150	M10	20	100	68
IL50/170-5,5/2	50	103	120	139	164	143	48	236	340	596	170	M10	20	100	80
IL50/170-7,5/2	50	103	120	139	164	143	48	236	340	596	170	M10	20	100	92
IL50/170-11/2	50	103	120	139	164	143	48	274	340	716	170	M10	20	100	128
IL50/170-15/2	50	120	145	150	160	170	70	274	440	751	190	M10	20	100	180
IL50/220-7,5/2	50	120	145	150	160	170	70	236	440	722	190	M10	20	100	125
IL50/220-11/2	50	120	145	150	160	170	70	274	440	742	190	M10	20	100	138
IL50/220-15/2	50	120	145	150	160	170	70	274	440	742	190	M10	20	100	143
IL50/220-18,5/2	50	120	145	150	160	170	70	317	440	782	190	M10	20	100	170
IL50/220-22/2	50	120	145	150	160	170	70	365	440	818	190	M10	20	100	200
IL65/140-4/2	65	120	112	134	140	140	60	193	340	503	160	M12	20	110	72
IL65/140-5,5/2	65	120	112	134	140	140	60	236	340	600	160	M12	20	110	84
IL65/140-7,5/2	65	120	112	134	140	140	60	236	340	600	160	M12	20	110	89
IL65/140-11/2	65	120	112	134	140	140	60	274	340	718	160	M12	20	110	121
IL65/140-15/2	65	120	112	134	140	140	60	274	340	718	160	M12	20	110	137
IL65/140-18,5/2	65	120	112	134	140	140	60	317	340	798	160	M12	20	110	187
IL65/170-7,5/2	65	110	127	147	180	195	60	236	430	602	215	M12	20	120	97
IL65/170-11/2	65	110	127	147	180	195	60	274	430	721	215	M12	20	120	134
IL65/170-15/2	65	110	127	147	180	195	60	274	430	756	215	M12	20	120	186
IL65/170-18,5/2	65	110	127	147	180	195	60	317	430	800	215	M12	20	120	202
IL65/170-22/2	65	110	127	147	180	195	60	365	430	836	215	M12	20	120	235
IL65/220-18,5/2	65	130	150	168	200	225	50	317	475	795	245	M12	20	110	220
IL65/220-22/2	65	130	150	168	200	225	50	365	475	831	245	M12	20	110	252
IL65/220-30/2	65	130	150	168	200	225	50	365	475	857	245	M12	20	110	320
IL65/220-37/2	65	130	150	168	200	225	50	384	475	966	245	M12	20	110	345
IL80/140-5,5/2	65	105	123	151	180	173	57	236	400	617	200	M12	20	120	82
IL80/140-7,5/2	65	105	123	151	180	173	57	236	400	617	200	M12	20	120	97
IL80/140-11/2	65	105	123	151	180	173	57	274	400	736	200	M12	20	120	130
IL80/140-15/2	65	105	123	151	180	173	57	274	400	736	200	M12	20	120	145
IL80/140-18,5/2	65	105	123	151	180	173	57	317	400	815	200	M12	20	120	195
IL80/170-11/2	80	120	136	162	180	173	72	274	440	719	200	M12	20	120	142
IL80/170-15/2	80	120	136	162	180	173	72	274	440	754	200	M12	20	120	194
IL80/170-18,5/2	80	120	136	162	180	173	72	317	440	798	200	M12	20	120	210
IL80/170-22/2	80	120	136	162	180	173	72	365	440	834	200	M12	20	120	240
IL80/170-30/2	80	120	136	162	180	173	72	365	440	860	200	M12	20	120	300
IL80/220-22/2	80	145	157	182	220	208	62	365	500	838	230	M12	20	120	258
IL80/220-30/2	80	145	157	182	220	208	62	365	500	864	230	M12	20	120	330
IL80/220-37/2	80	145	157	182	220	208	62	384	500	973	230	M12	20	120	356
IL80/220-45/2	80	145	157	182	220	208	62	384	500	973	230	M12	20	120	391
IL100/170-22/2	100	120	158	196	200	226	60	365	500	869	250	M12	20	135	252
IL100/170-30/2	100	120	158	196	200	226	60	365	500	896	250	M12	20	135	325
IL100/170-37/2	100	120	158	196	200	226	60	384	500	1004	250	M12	20	135	352
IL100/170-45/2	100	120	158	196	200	226	60	384	500	1004	250	M12	20	135	388
IL100/220-37/2	100	155	173	202	220	231	99	384	550	983	255	M12	20	110	373
IL100/220-45/2	100	155	173	202	220	231	99	384	550	983	255	M12	20	110	408

# In-Line Pumps

## IL Series



Dimension 6pole

Model	DN	a	b <sub>1</sub>	b <sub>2</sub>	c	e	f	øg	l <sub>0</sub>	~l <sub>1</sub>	m	o	p	x	Weight
															[kg]
[mm]															
IL32/170-0,4/6	32	100	112	124	120	132	68	175	320	436	155	M10	20	90	44
IL40/170-0,4/6	40	82	113	129	130	149	58	175	340	450	170	M10	20	95	47
IL40/170-0,55/6	40	82	113	129	130	149	58	193	340	516	170	M10	20	95	52
IL50/170-0,4/6	50	103	120	139	164	143	48	175	340	456	170	M10	20	100	51
IL50/170-0,55/6	50	103	120	139	164	143	48	193	340	522	170	M10	20	100	56
IL50/170-0,75/6	50	103	120	139	164	143	48	193	340	522	170	M10	20	100	58
IL65/170-0,4/6	65	110	127	147	180	195	60	175	430	462	215	M12	20	120	57
IL65/170-0,55/6	65	110	127	147	180	195	60	193	430	528	215	M12	20	120	62
IL65/170-0,75/6	65	110	127	147	180	195	60	193	430	528	215	M12	20	120	64
IL65/170-1,1/6	65	110	127	147	180	195	60	236	430	593	215	M12	20	120	72
IL80/170-0,4/6	80	120	136	162	180	173	72	175	440	460	200	M12	20	120	66
IL80/170-0,55/6	80	120	136	162	180	173	72	193	440	526	200	M12	20	120	71
IL80/170-0,75/6	80	120	136	162	180	173	72	193	440	526	200	M12	20	120	73
IL80/170-1,1/6	80	120	136	162	180	173	72	236	440	589	200	M12	20	120	83
IL80/170-1,5/6	80	120	136	162	180	173	72	236	440	589	200	M12	20	120	87
IL100/170-1,1/6	100	120	158	196	200	226	60	236	500	623	250	M12	20	135	96
IL100/170-1,5/6	100	120	158	196	200	226	60	236	500	623	250				



# In-Line Pumps

## IL Series

Sectional Drawing

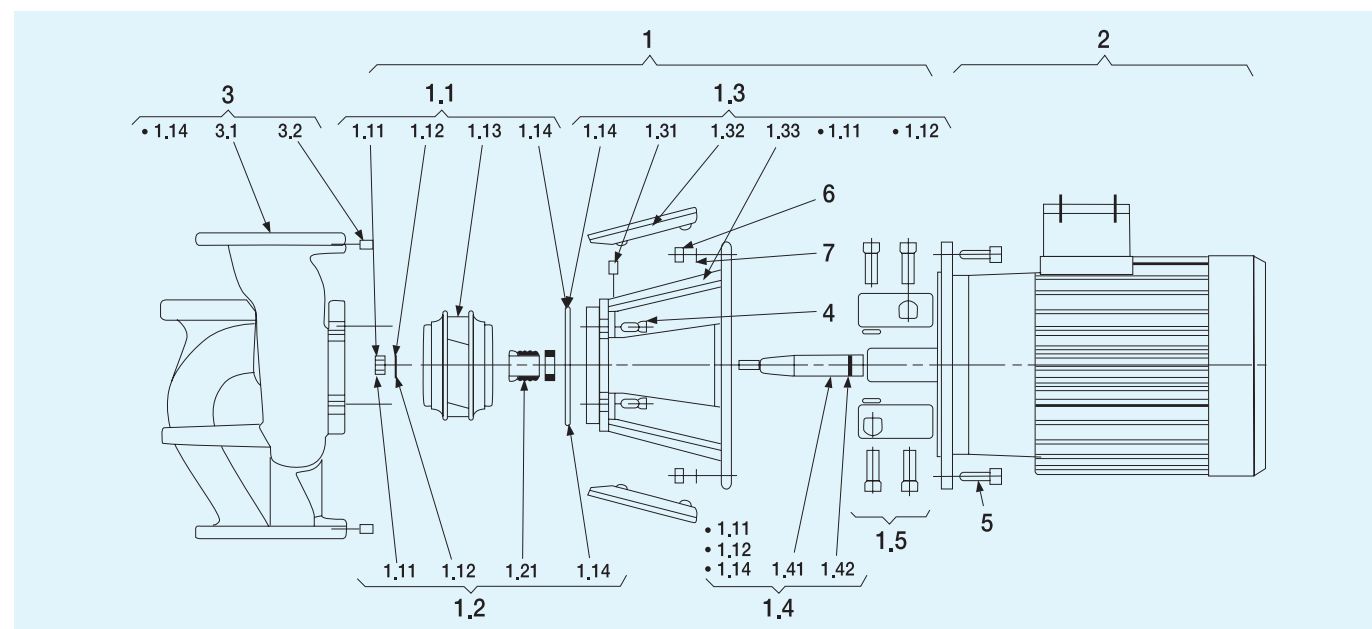

Note : IL 250 series excluded

Description and Part Name		Standards	
1 Exchange set complete	1.1 Set impeller with	1.11 Nut	DIN934 A2
		1.12 Plain washer	DIN125 A2
		1.13 Impeller	EN-GJL200
		1.14 O-ring	EPDM
	1.2 Set mechanical seal with	1.11 Nut	DIN934 A2
		1.12 Plain washer	DIN125 A2
		1.14 O-ring	EPDM
		1.21 Mechanical seal complete	AQ1EGG
	1.3 Set lantern with	1.1 Nut	DIN934 A2
		1.12 Plain washer	DIN125 A2
		1.14 O-ring	EPDM
		1.31 Vent screw	CuZn39Pb2
		1.32 Coupling protection cap	PA66
	1.4 Set shaft with	1.11 Nut	DIN934 A2
		1.12 Plain washer	DIN125 A2
		1.14 O-ring	EPDM
1.41 Shaft		1.4122	
1.5 Coupling complete	1.42 Snap ring	DIN7993 A2	
		-	
2 Motor		-	
3 Pumphousing complete with	1.14 O-ring	EPDM	
	3.1 Pump housing	EN-GJL250	
	3.2 Gauge plug	DIN906 8.8	
4 Fixing-screws lantern / pumphousing		DIN912 8.8	
5 Fixing-screws motor / lantern		DIN912 8.8	
6 Fixing-nut motor / lantern		DIN934 8	
7 Plain washer motor / lantern		DIN125 ST	

※ Above data can be different per model

# In-Line Pumps

## PIL Series

Product Introduction



### Product Advantage

1. It is easy to install within pipes and possible to change the mechanical seal without disassembling the pump casing from pipes
2. Pump and motor shaft are in one unit so that it prevents bad alignment
3. Mechanical seal that is lubricated by internal fluids in pump is installed for sealing
4. It brings compactness and lightness by using aluminium framed motor. (Note that it will be cast iron framed if motor rating is above 15HP)

### Standard Specification

Applicable fluids		0℃~120℃ Clean water(pH6-8)
Working range	Flow rate	3~480m³/h
	Head	5~55m
	Motor power	1~100HP
Maximum working pressure		10kgf/cm² (16kgf/cm² is optional)
Structure	Impeller	Closed Type
	Sealing	Mechanical Seal
Flange		KS 10kgf/cm² RF(16kgf/cm² RF is optional)
Motor	Phase,Poles	Three phase, 4 pole
	Voltage	Below 10HP, then 220/380V Above 15HP, then 380V(Y-D)
	Frequency	60Hz
	Insulation class	F
	Protection class	IP44 (IP54 is optional)
Type		TEFC
Installation site		Indoor

※ In case of using hot, special fluids, please contact us as mechanical seal, pump body, motor's anti-abrasion, corrosion-proof might change remarkably due to the working condition and features(temp, load, density, amount of solid material) of the fluid.

### Application

- Cold/Hot water circulation of buildings
- Hot water circulation of townhouse, hot bath circulation
- Agricultural fluid delivery equipment

### Minimum suction total head

Temperature of fluid	bore for suction	suction total head
0℃ - 40℃	40-80mm	Less than -6m
	100-125mm	Less than -5.5m

### Compensation factor on temperature

Temperature	Extra head(m)
40℃-50℃	+1
50℃-60℃	+2
60℃-70℃	+3.5
70℃-80℃	+5
80℃-90℃	+7
90℃-95℃	+9
95℃-100℃	+11

### Options

- Base plate
- Use of different materia for hydraulic components
- Use of different material for mechanical seal
- Counter flange
- Change of motor type, structure, power, frequency, voltage



# In-Line Pumps

## PIL Series

Model

### Standard Model

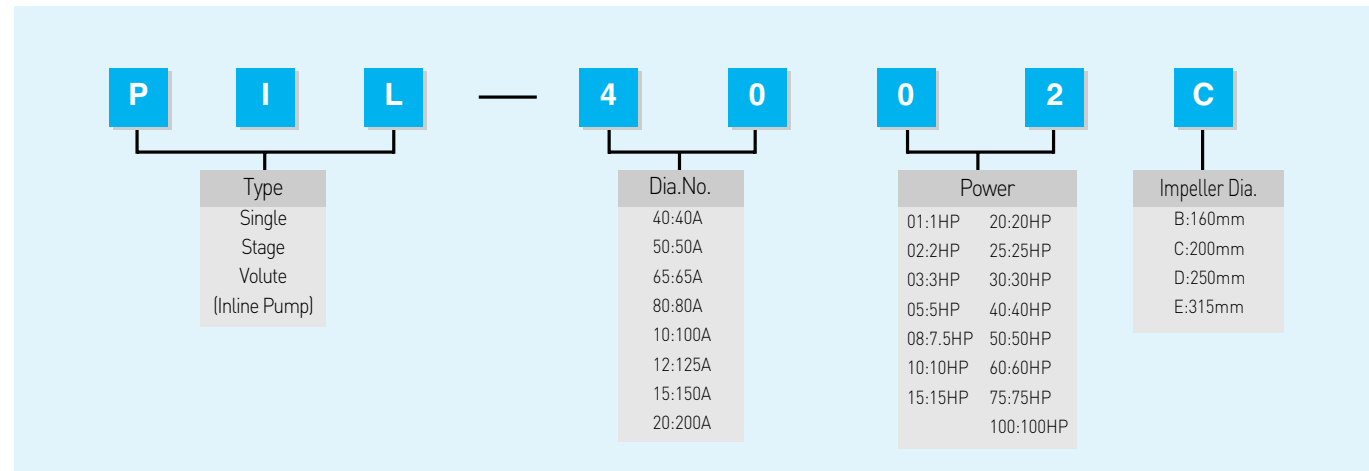

### Detailed designation

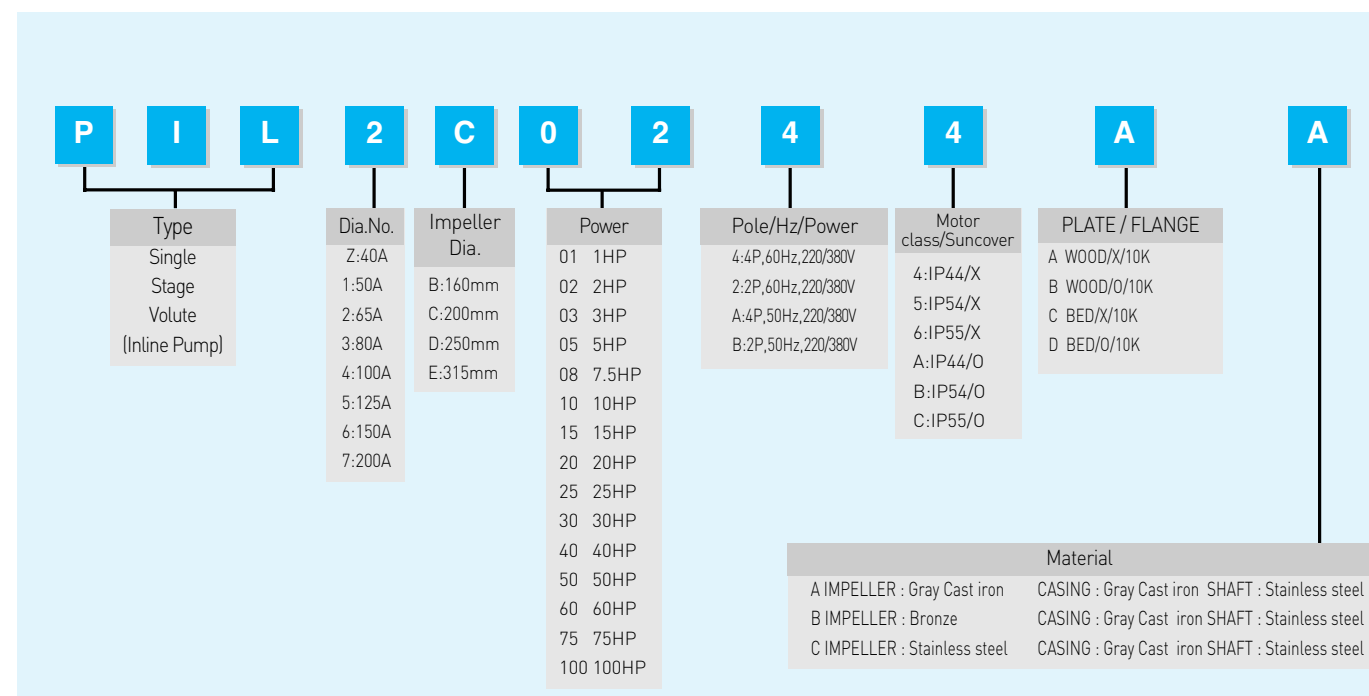

\* Detailed designation may be changed for other options.

# In-Line Pumps

## PIL Series



Selection Chart & Flange Dimension

### Selection Chart

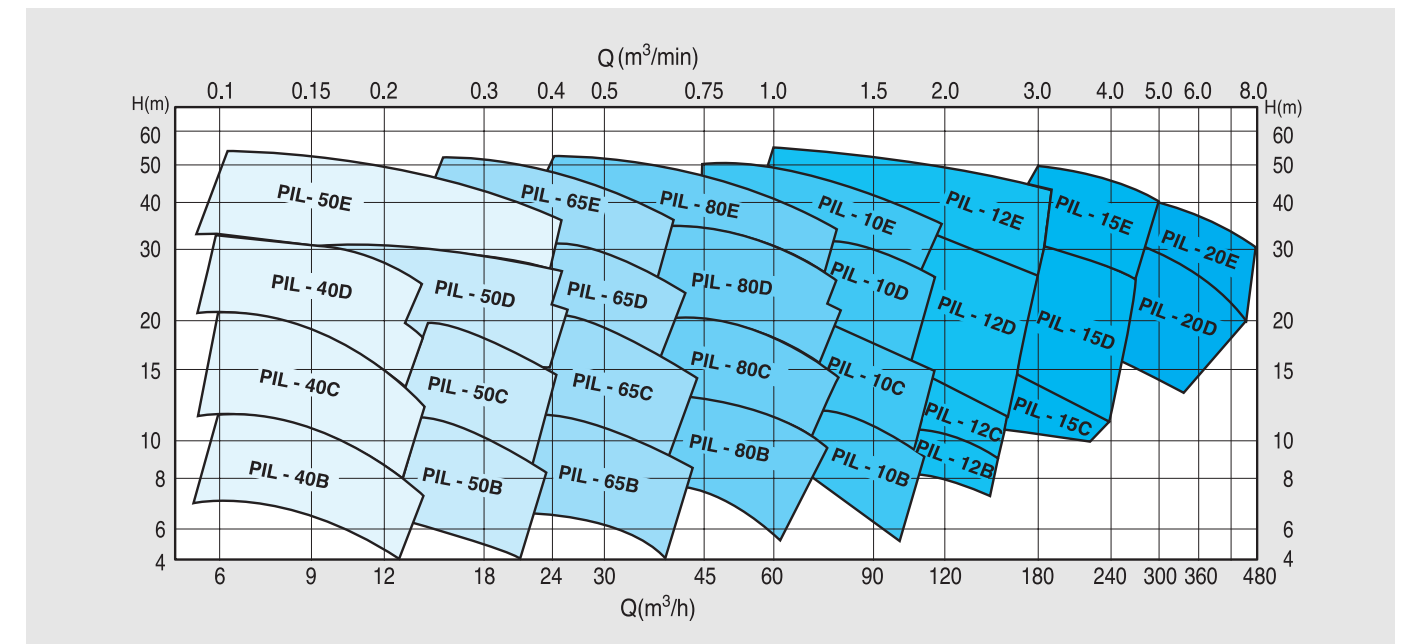

### Flange Dimension

KS Flange

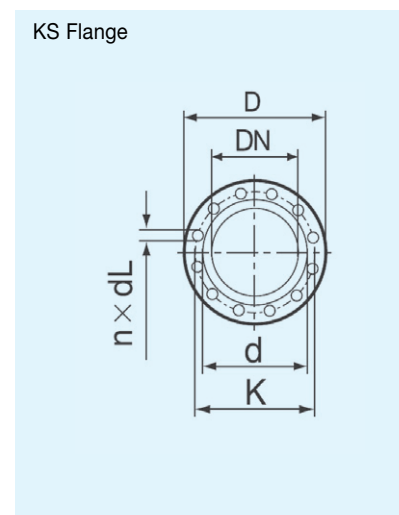

Rating	Bore(DN)	D	d	K	n	dL	Bolt
10kgf/cm <sup>2</sup>	32	135	76	100	4	19	M16
	40	140	81	105	4	19	M16
	50	155	96	120	4	19	M16
	65	175	116	140	4	19	M16
	80	185	126	150	8	19	M16
	100	210	151	175	8	19	M16
	125	250	182	210	8	23	M20
	150	280	212	240	8	23	M20
16kgf/cm <sup>2</sup>	200	330	262	290	12	23	M20
	250	400	324	355	12	25	M22
	300	445	368	400	16	25	M22
	32	135	76	100	4	19	M16
	40	140	81	105	4	19	M16
	50	155	96	120	8	19	M16
	65	175	116	140	8	19	M16
	80	200	132	160	8	23	M20
20kgf/cm <sup>2</sup>	100	225	160	185	8	23	M20
	125	270	195	225	8	25	M22
	150	305	230	260	12	25	M22
	200	350	275	305	12	25	M22
	250	430	345	380	12	27	M24
	300	480	395	430	16	27	M24
	32	135	76	100	4	19	M16
	40	140	81	105	4	19	M16



# In-Line Pumps

## PIL Series

Sectional Drawing

### SECTIONAL DRAWING(40B ~ 15D)

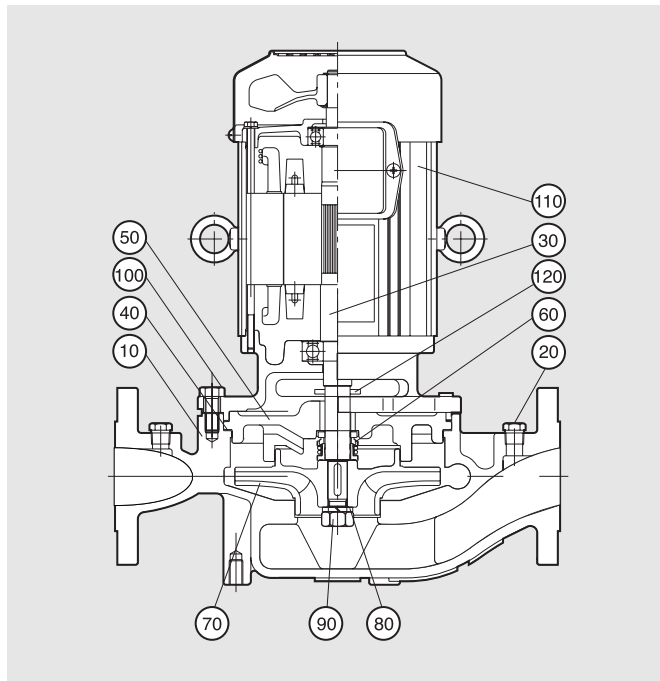

Parts	Stadard material
10 Casing	Gary Cast Iron
20 Plug	Steel
30 Shaft	Stainless Steel
40 Casing Gasket	Rubber
50 Casing Cover	Gary Cast Iron
60 M/Seal	SiC/Carbon
70 Impeller	Gary Cast Iron ★ (Bronze, Stainless Casting)
80 Washer	STS304
90 Nut	Steel
100 Bolt	Steel
110 Motor	-
120 Deflector	Rubber

※ ★ Optional.  
※ Please contact us for motor option.

### SECTIONAL DRAWING(15E ~ 20E)

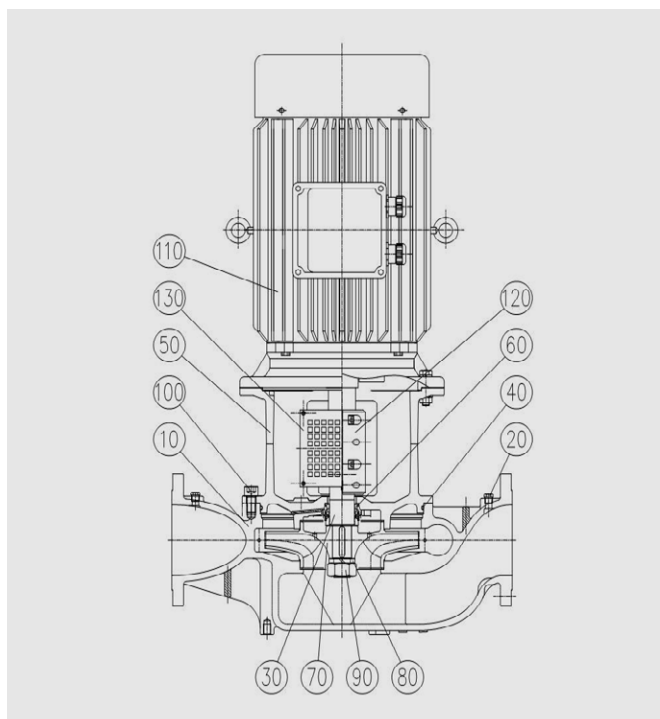

Parts	Stadard material
10 Casing	Gary Cast Iron
20 Plug	Steel
30 Shaft	Stainless Steel
40 Casing O-ring	Rubber
50 Lantern	Gary Cast Iron
60 M/Seal	SiC/Carbon
70 Impeller	Gary Cast Iron ★ (Bronze, Stainless Casting)
80 Impeller Washer	STS304
90 Impeller Nut	Steel
100 Socket Bolt	Steel
110 Motor	-
120 Coupling	Steel
130 Coupling Guard	Steel

# In-Line Pumps

## PIL Series



Product Features

### Advantages

#### 1. Casing

- Rectification panel is installed at suction side to improve its suction, and it reduces vortex and cavitations of circulating water.
- Able to apply pressure at 16kgf/cm<sup>2</sup> as an option. Note that we do not guarantee for water hammer.
- Plug(3/8", 1/4") for pressure gauge at suction and discharge side.
- Tap is installed to enable installation on the ground
- Drain plug(3/8") is installed for long term storage.

#### 2. Impeller

- Minimized friction loss by shell core casting
- It brings excellent pumping by 3D engineering vane.
- Impeller washer made of STS304 is corrosion resistant.

#### 3. Mechanical seal

- Carbon/SiC as standard
- Max temp of liquid : 120℃
- Glycol up to 20%(40% as an option)
- No leakage even in temporary back lashing.
- Flushing hole integrated for lubrication and cooling.
- Mono bloc pump for easy maintenance

#### 4. Motor

- Aluminum frame (under 10HP) is supplied.
- Able to provide an optional model which enables an operation at 16kgf/cm<sup>2</sup> and is using closed ball bearings.
- STS410 for the shaft

### Standard Specification

Model	Suction/ Discharge	Motor rating		Standard spec.		Range m <sup>3</sup> /hr	
		(HP)	(kW)	m <sup>3</sup> /hr	m	min.	max.
PIL-4001B	40X40	1	0.75	7.2	10	3.6	15
PIL-4002B	40X40	2	1.5		13		
PIL-5001B	50X50	1	0.75	15	8	6	21
PIL-5002B	50X50	2	1.5		11.5		
PIL-6502B	65X65	2	1.5	30	9	10.2	36
PIL-6503B	65X65	3	2.2		11.5		
PIL-8003B	80X80	3	2.2	60	8	16.8	66
PIL-8005B	80X80	5	3.7		10.5		
PIL-1005B	100X100	5	3.7	94.8	8	27	105
PIL-1008B	100X100	7.5	5.5		10		
PIL-1208B	125X125	7.5	5.5	120	9	42	168
PIL-1210B	125X125	10	7.5		12.5		
PIL-4002C	40X40	2	1.5	7.2	18	3.6	18
PIL-5003C	50X50	3	2.2		15		
PIL-6503C	65X65	3	2.2	30	12	10.2	42
PIL-6505C	65X65	5	3.7		18		
PIL-8005C	80X80	5	3.7	60	12	16.8	78
PIL-8008C	80X80	7.5	5.5		18		
PIL-8010C	80X80	10	7.5	96	18	27	105
PIL-1008C	100X100	7.5	5.5		12		
PIL-1010C	100X100	10	7.5	96	15	27	105
PIL-1210C	125X125	10	7.5		10		
PIL-1215C	125X125	15	11	150	10	42	168
PIL-1515C	150X150	15	11		15		
PIL-1515C	150X150	15	11	210	11.5	72	270
PIL-1520C	150X150	20	15		16		
PIL-1525C	150X150	25	18.5	150	17	72	270
PIL-4003D	40X40	3	2.2		9		
PIL-4005D	40X40	5	3.7	9	24	3.6	18
PIL-5005D	50X50	5	3.7		29		
PIL-5008D	50X50	7.5	5.5	15	24	6	27
PIL-6505D	65X65	5	3.7		29		
PIL-6508D	65X65	7.5	5.5	30	19	10.2	42
PIL-8008D	80X80	7.5	5.5		29		
PIL-8010D	80X80	10	7.5	60	18	16.8	78
PIL-8015D	80X80	15	11		24		
PIL-1010D	100X100	10	7.5	96	29	27	105
PIL-1015D	100X100	15	11		15		
PIL-1020D	100X100	20	15	150	27	42	168
PIL-1215D	125X125	15	11		15		
PIL-1220D	125X125	20	15	150	21	72	270
PIL-1225D	125X125	25	18.5		26		
PIL-1230D	125X125	30	22	240	28	90	480
PIL-1525D	150X150	25	18.5		17		
PIL-1530D	150X150	30	22	240	21	72	270
PIL-1540D	150X150	40	30		26		
PIL-2040D	200X200	40	30	390	19	90	480
PIL-2050D	200X200	50	37		23		
PIL-2060D	200X200	60	45	15	27	6	36
PIL-5008E	50X50	7.5	5.5		28		
PIL-5010E	50X50	10	7.5	30	35	10.2	42
PIL-5015E	50X50	15	11		46		
PIL-6510E	65X65	10	7.5	60	29	16.8	78
PIL-6515E	65X65	15	11		36		
PIL-8015E	80X80	15	11	240	29	72	270
PIL-8020E	80X80	20	15		46		
PIL-8025E	80X80	25	18.5	94.8	46	27	120
PIL-1020E	100X100	20	15		30		
PIL-1025E	100X100	25	18.5	150	34	42	168
PIL-1030E	100X100	30	22		41		
PIL-1230E	125X125	30	22	240	31	72	330
PIL-1240E	125X125	40	30		42		
PIL-1540E	150X150	40	30	390	25	90	480
PIL-1550E	150X150	50	37		32		
PIL-1560E	150X150	60	45	240	40	72	330
PIL-1575E	150X150	75	55		45		
PIL-2060E	200X200	60	45	94.8	28	27	120
PIL-2075E	200X200	75	55		32		
PIL-20100E	200X200	100	75	390	42	90	480
PIL-20100E	200X200	100	75		42		



# In-Line Pumps PIL Series

## Outline Dimension

### Outline Dimensions

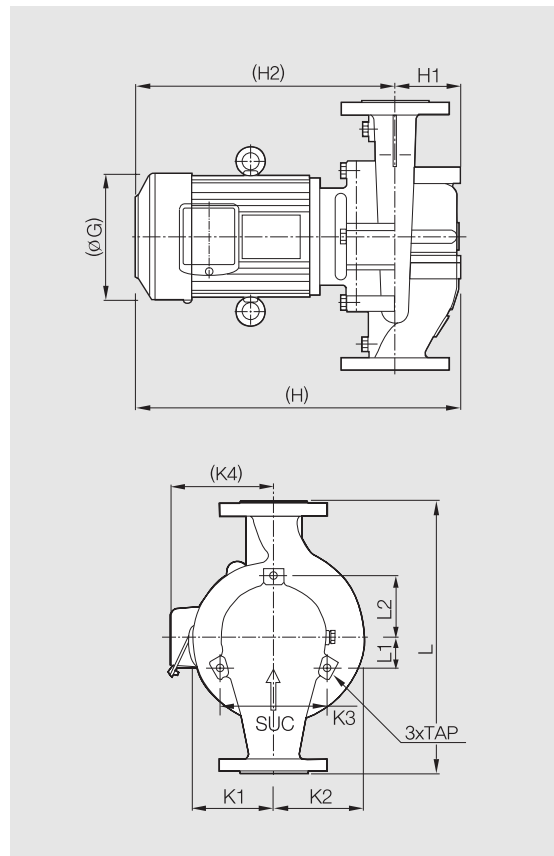

(1)

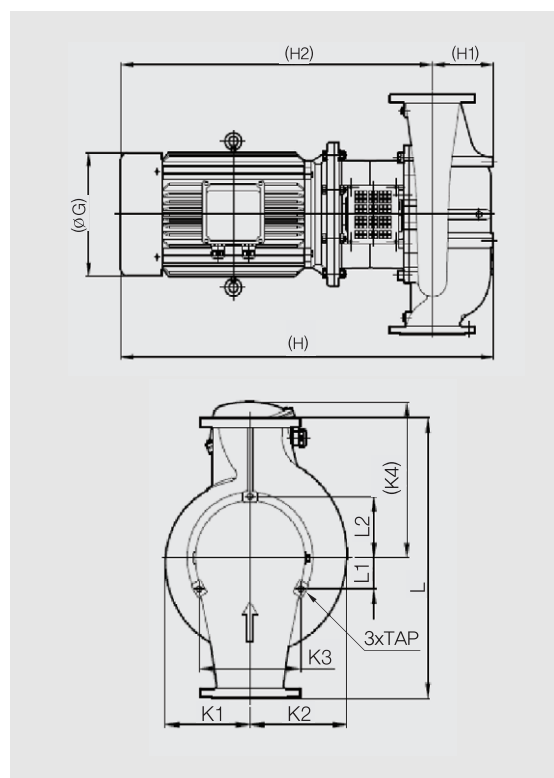

(2)

### Standard Dimension

Model	H	H1	K1	K2	K3	K4	L	L1	L2	Ø G	TAP	Wt. (kg)	No.
PIL-4001B	435	90	123	123	139	148	390	40	80	182	M12	52	1
PIL-4002B	475	90	123	123	139	148	390	40	80	182	M12	53	1
PIL-5001B	440	95	123	130	154	148	440	44.5	89	182	M12	53	1
PIL-5002B	480	95	123	130	154	148	440	44.5	89	182	M12	54	1
PIL-6502B	497	110	123	138	154	148	474	44.5	89	182	M12	60	1
PIL-6503B	497	110	123	138	154	164	474	44.5	89	213	M12	64	1
PIL-8003B	522	130	131	155	170	164	524	49	95	213	M12	66	1
PIL-8005B	552	130	131	155	170	164	524	49	95	213	M12	74	1
PIL-1005B	577	150	137	170.5	195	164	574	55	110	213	M12	102	1
PIL-1008B	587	150	137	170.5	195	224	574	55	110	248	M12	110	1
PIL-1208B	645	185	167	211	250	224	652	72	144	248	M16	125	1
PIL-1210B	670	185	167	211	250	224	652	72	144	248	M16	130	1
PIL-4002C	430	90	145	146	130	150	390	30	0	174	M12	53	1
PIL-5003C	461	100	145	149	154	167	440	60	85	218	M12	65	1
PIL-6503C	477	110	149	167	154	167	475	60	85	218	M12	71	1
PIL-6505C	507	110	149	167	154	167	475	60	85	218	M12	80	1
PIL-8005C	540	130	156	180	170	167	500	65	95	218	M12	89	1
PIL-8008C	577	130	156	180	170	185	500	65	95	248	M12	93	1
PIL-1008C	609	150	154	184	195	185	550	55	110	248	M12	99	1
PIL-1010C	636	150	154	184	195	185	550	55	110	248	M12	107	1
PIL-1210C	642	165	168	207	250	224	652	72	144	248	M16	130	1
PIL-1215C	712	165	168	207	250	265	652	72	144	317	M16	190	1
PIL-1515C	739	185	184	234	286	265	750	82.5	165	317	M16	210	1
PIL-1520C	837	185	184	234	286	265	750	82.5	165	317	M16	250	1
PIL-1525C	809	185	184	234	286	300	750	82.5	165	365	M16	260	1
PIL-4003D	455	90	176	176	154	167	474	44.5	89	218	M12	72	1
PIL-4005D	485	90	176	176	154	167	474	44.5	89	218	M12	81	1
PIL-5005D	496	100	176	186	154	167	474	44.5	89	218	M12	76	1
PIL-5008D	533	100	176	186	154	185	474	44.5	89	248	M12	80	1
PIL-6505D	512	115	176	176	195	167	524	55	110	218	M12	88	1
PIL-6508D	549	115	176	176	195	185	524	55	110	248	M12	92	1
PIL-8008D	600	130	176	194	195	185	550	55	110	248	M12	105	1
PIL-8010D	613	130	176	194	195	185	550	55	110	248	M12	110	1
PIL-8015D	670	130	176	194	195	265	550	55	110	317	M12	180	1
PIL-1010D	637	140	185	212	225	185	620	65	130	248	M12	120	1
PIL-1015D	694	140	185	212	225	265	620	65	130	317	M12	180	1
PIL-1020D	738	140	185	212	225	265	620	65	130	317	M12	193	1
PIL-1215D	754	165	182	212	250	265	700	72	144	317	M16	187	1
PIL-1220D	754	165	182	212	250	265	700	72	144	317	M16	230	1
PIL-1225D	770	165	182	212	250	299	700	72	144	358	M16	248	1
PIL-1230D	770	165	182	212	250	299	700	72	144	358	M16	261	1
PIL-1525D	794	200	197	240	286	265	750	82.5	165	317	M16	262	1
PIL-1530D	794	200	197	240	286	299	750	82.5	165	358	M16	274	1
PIL-1540D	814	200	197	240	286	299	750	82.5	165	358	M16	292	1
PIL-5008E	550	110	203	203	195	185	524	55	110	248	M12	98	1
PIL-5010E	580	110	203	203	195	185	524	55	110	248	M12	100	1
PIL-5015E	644	110	203	203	195	265	524	55	110	317	M12	170	1
PIL-6510E	601	130	202	212	195	185	600	55	110	248	M12	102	1
PIL-6515E	665	130	202	212	195	265	600	55	110	317	M12	179	1
PIL-8015E	695	150	203	218	195	265	650	55	110	317	M12	200	1
PIL-8020E	739	150	203	218	195	265	650	55	110	317	M12	225	1
PIL-8025E	739	150	203	218	195	299	650	55	110	358	M12	242	1
PIL-1020E	744	165	205	222	225	299	700	65	130	317	M12	230	1
PIL-1025E	744	165	205	222	225	299	700	65	130	358	M12	250	1
PIL-1030E	744	165	205	222	225	299	700	65	130	358	M12	258	1
PIL-1230E	769	185	220	245	250	299	700	72	144	358	M16	274	1
PIL-1240E	814	185	220	245	250	299	700	72	144	358	M16	292	1
PIL-1540E	1088	200	238	273	286	300	750	82.5	165	365	M16	410	2
PIL-1550E	1224	200	238	273	286	360	750	82.5	165	384	M16	485	2
PIL-1560E	1231	200	238	273	286	360	750	82.5	165	384	M16	505	2
PIL-1575E	1282	200	238	273	286	425	750	82.5	165	454	M16	600	2
PIL-2040D	1141	240	250	308	395	300	905	114	228	365	M16	450	2
PIL-2050D	1277	240	250	308	395	360	905	114	228	384	M16	525	2
PIL-2060D	1284	240	250	308	395	360	905	114	228	384	M16	545	2
PIL-2060E	1280	240	300	360	395	360	905	114	228	384	M16	575	2
PIL-2075E	1330	240	300	360	395	425	905	114	228	454	M16	670	2
PIL-20100E	1378	240	300	360	395	440	905	114	228	514	M16	830	2

★ Above dimension can be changed without prior notice

# In-Line Pumps PIL Series



## Performance curve

### PIL- 4001B~PIL- 4002C

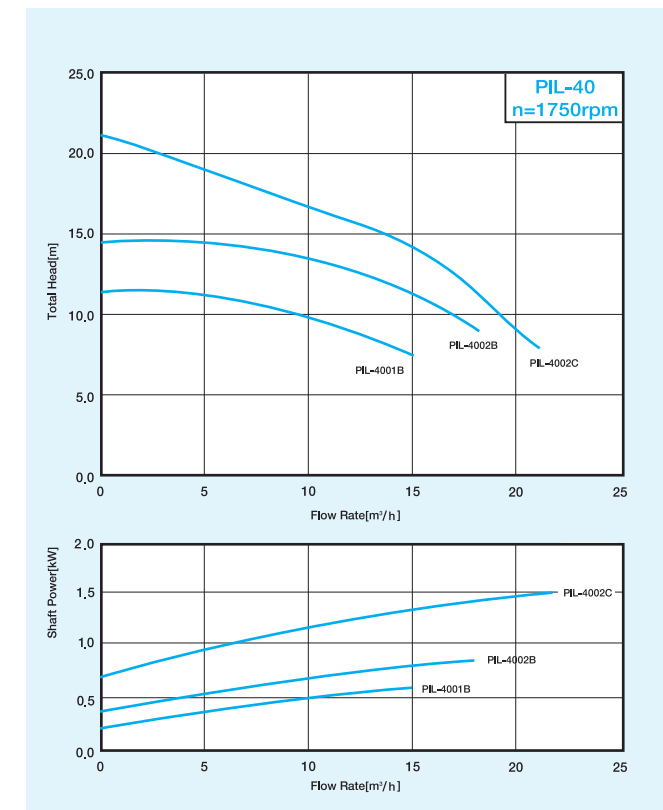

### PIL- 5001B~PIL- 5008D

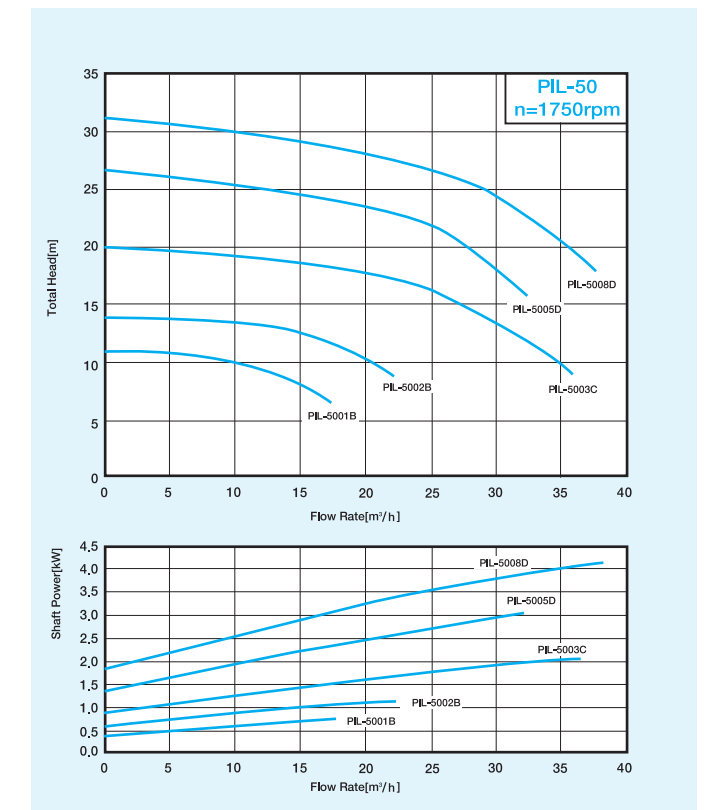

### PIL- 4003D~PIL- 4005D

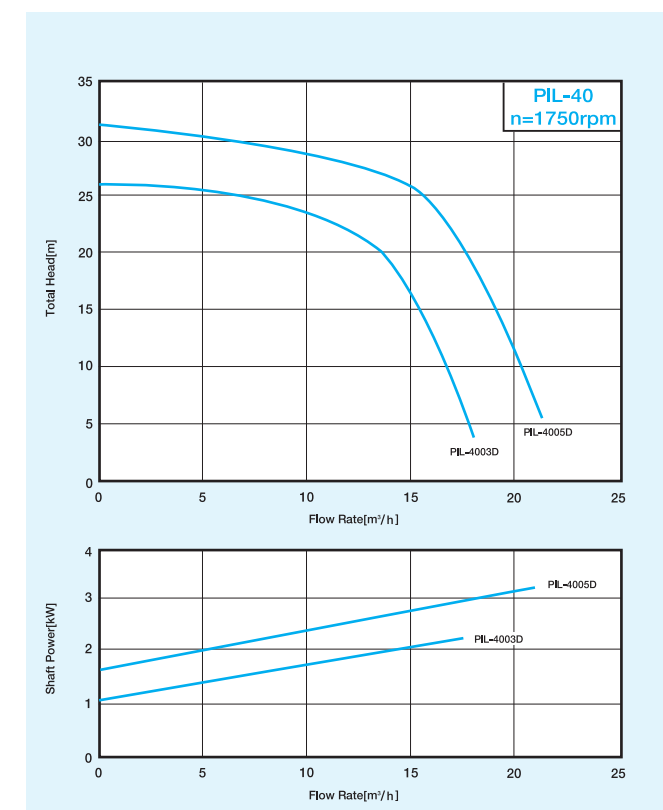

### PIL- 5008E~PIL- 5015E

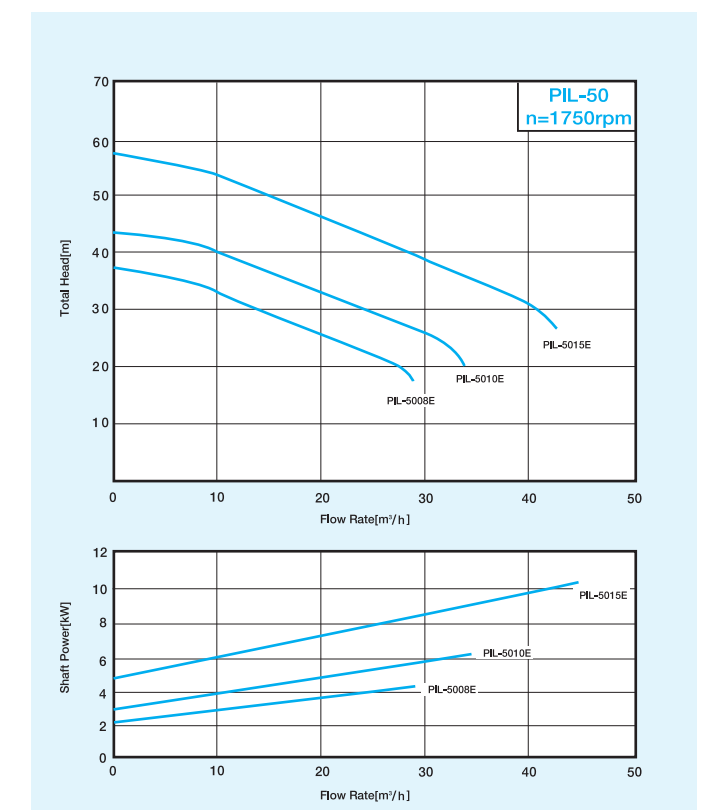



# In-Line Pumps PIL Series

Performance curve

PIL- 6502B~PIL- 6505C

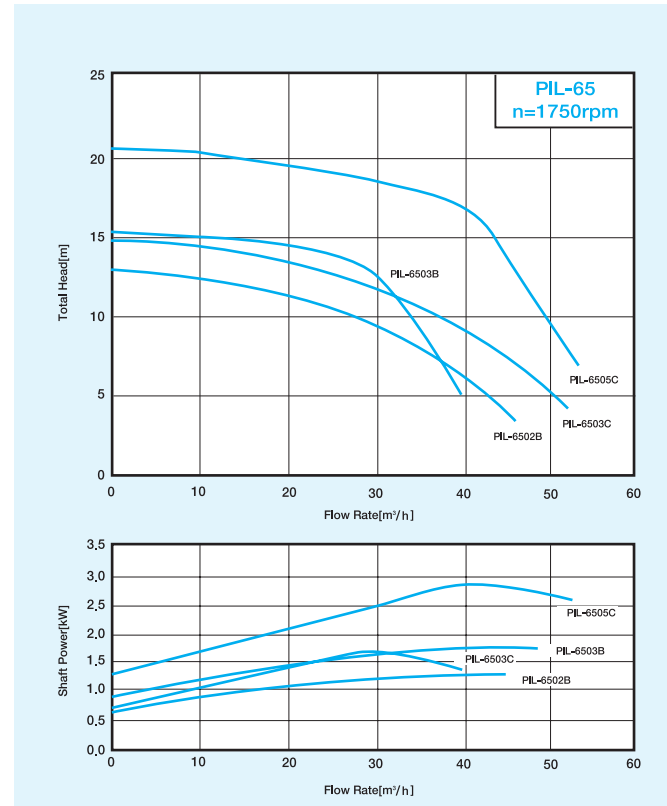

PIL- 8003B~PIL- 8008C

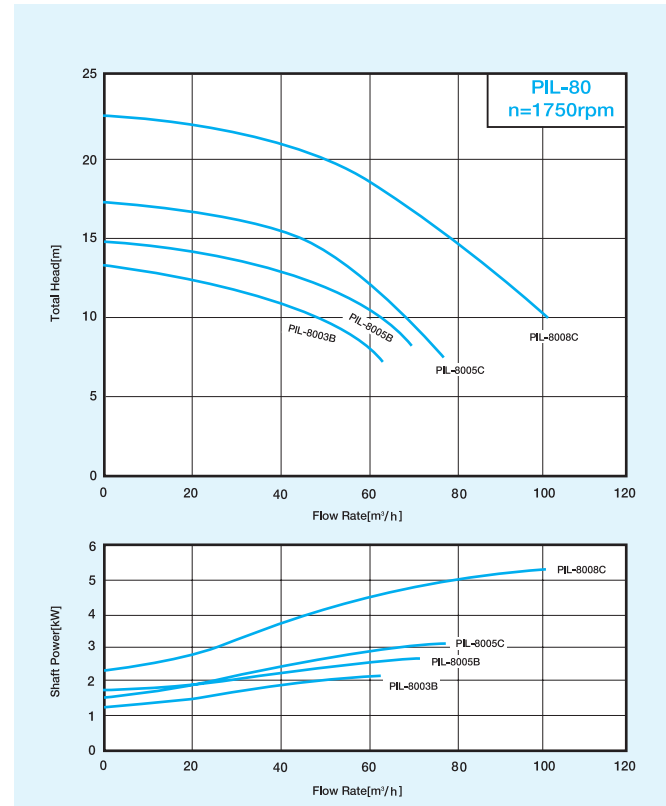

PIL- 6505D~PIL- 6515E

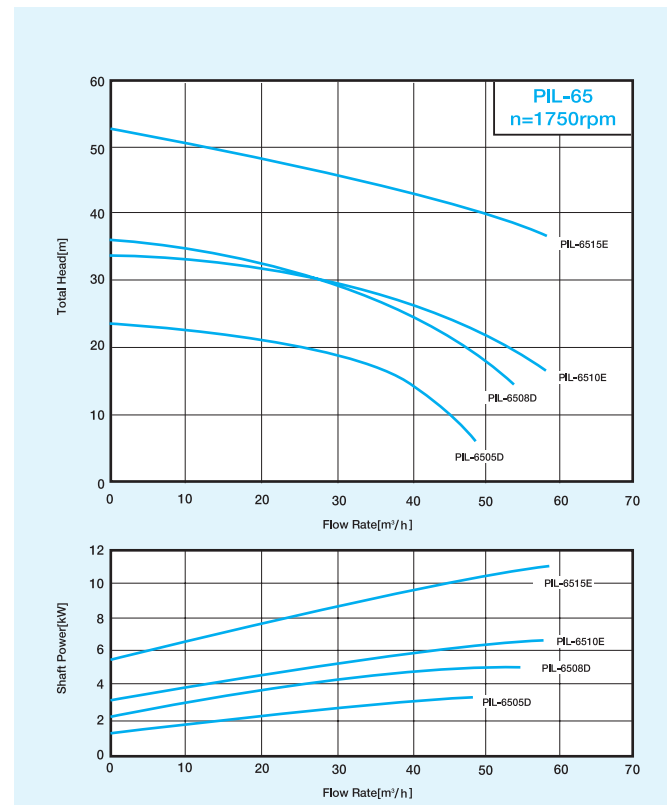

PIL- 8008D~PIL- 8025E

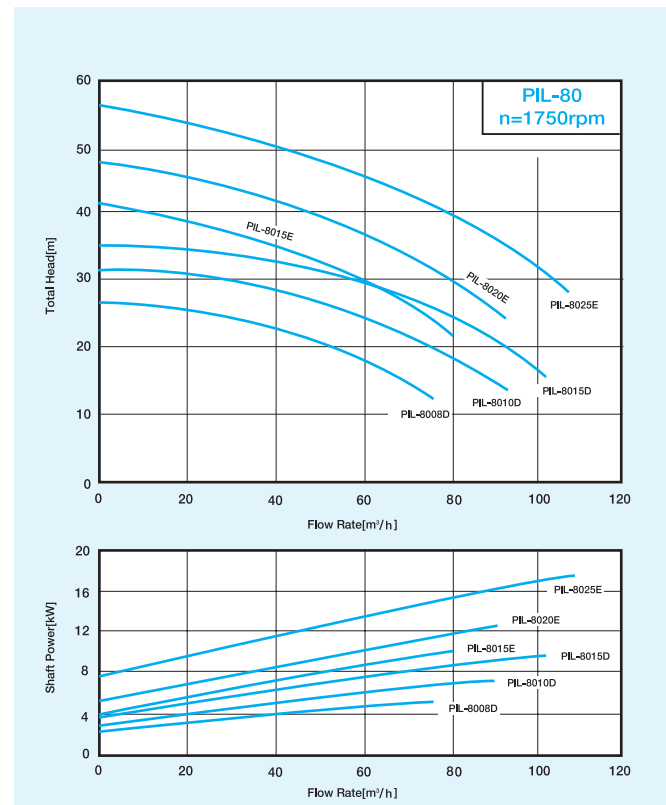

# In-Line Pumps PIL Series

Performance curve



PIL- 1005B~PIL- 1010C

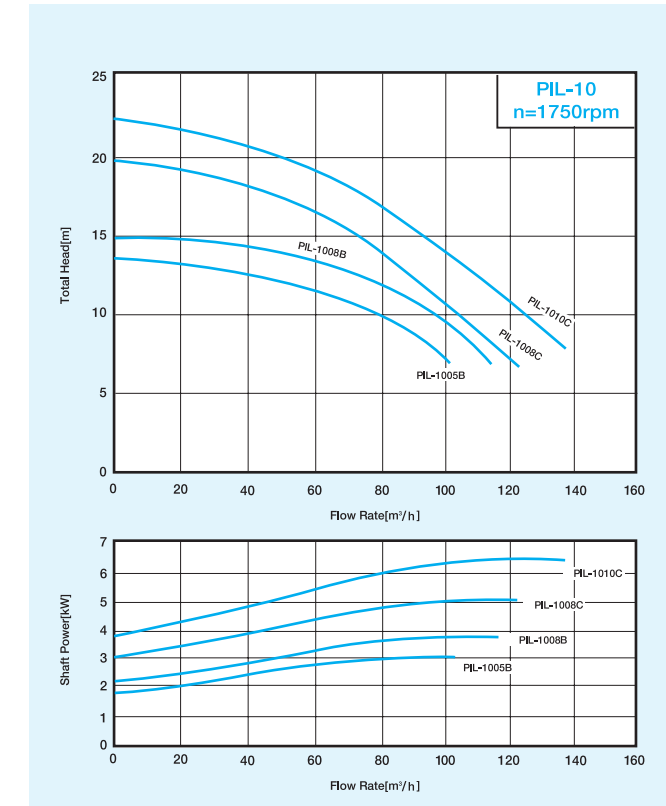

PIL- 1208B~PIL- 1215C

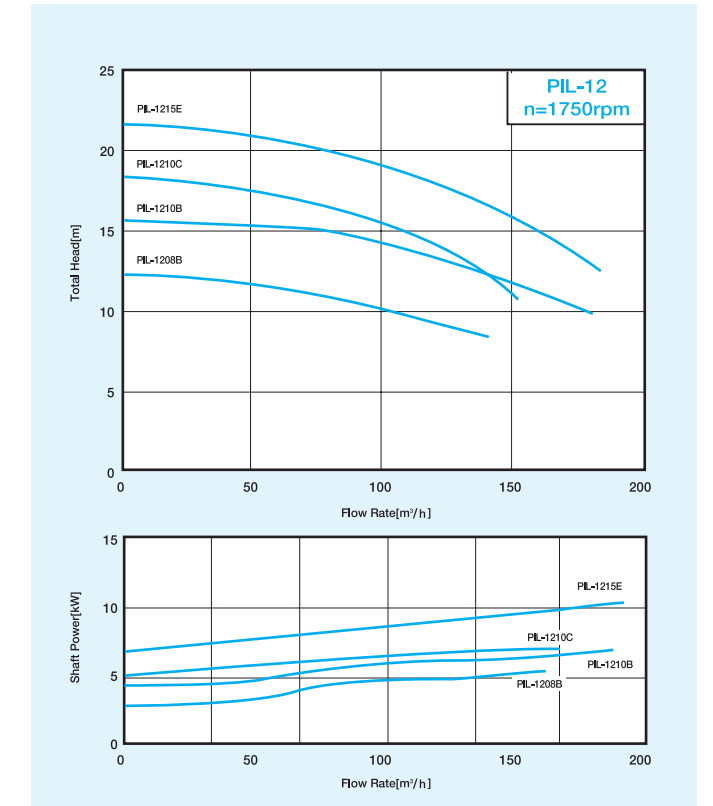

PIL- 1010D~PIL- 1030E

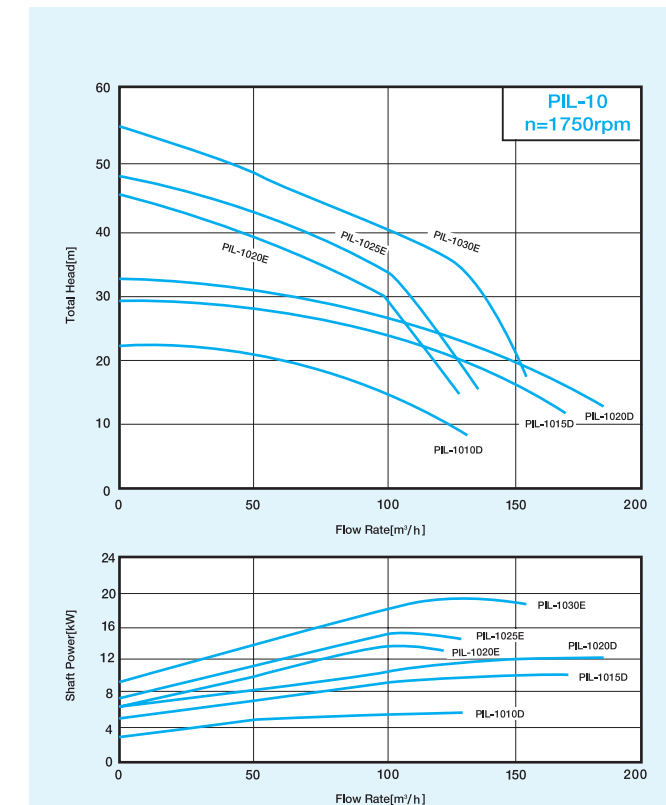

PIL- 1215D~PIL- 1240E

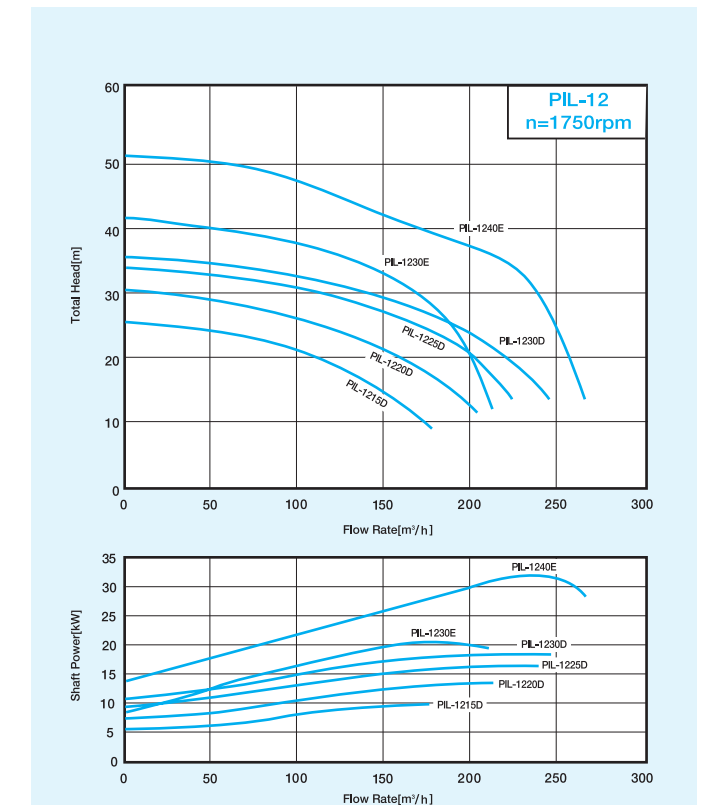



# In-Line Pumps

## PIL Series

Performance curve

PIL- 1515C~PIL-1540D

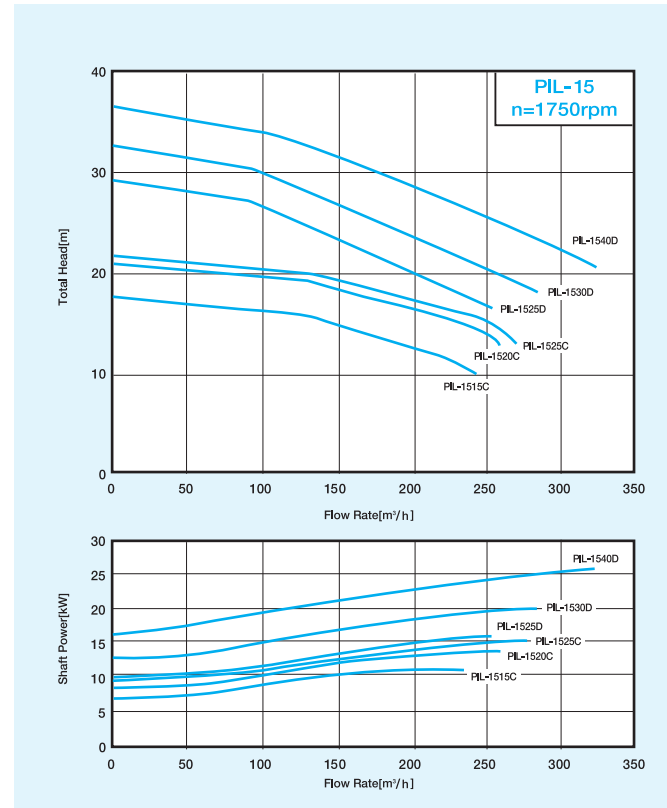

PIL- 2040D~PIL- 2060D

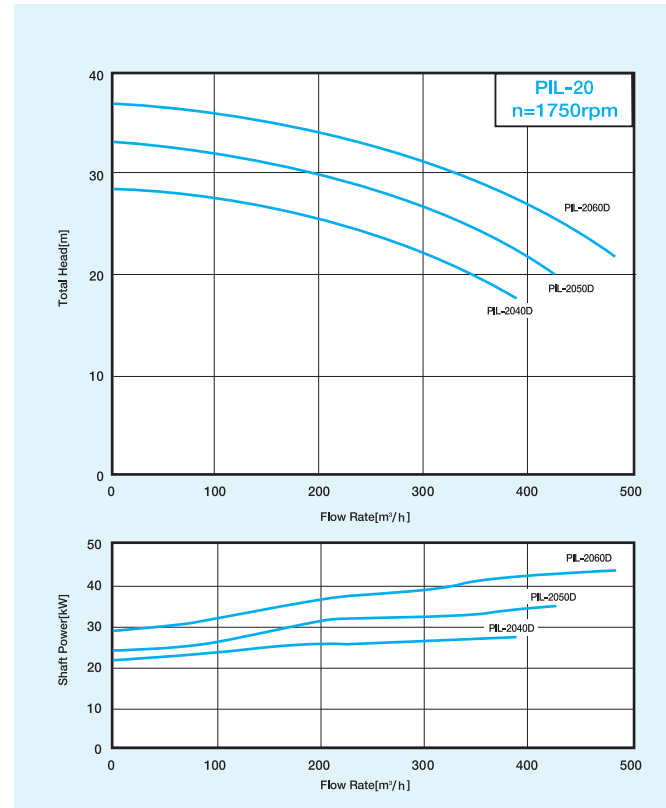

PIL- 1540E~PIL-1575E

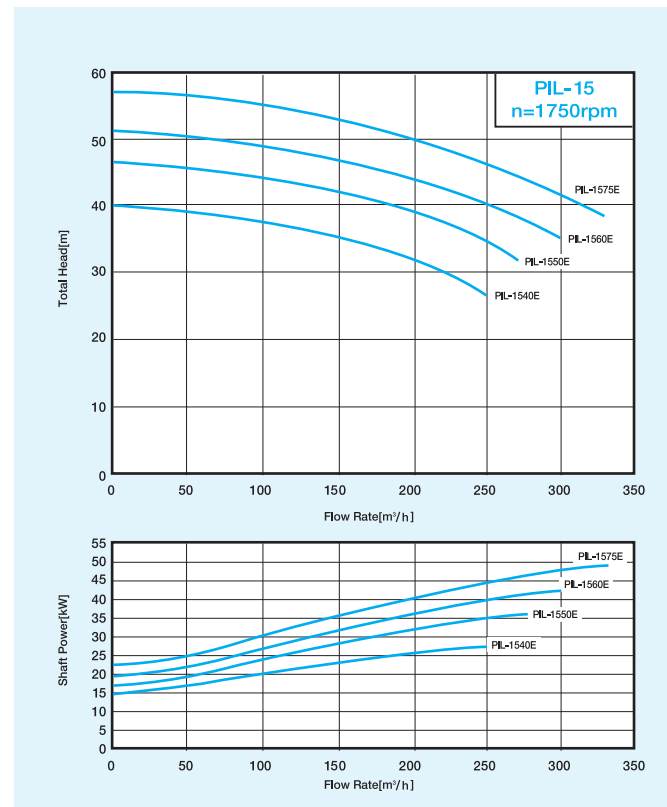

PIL- 2060E~PIL- 20100E

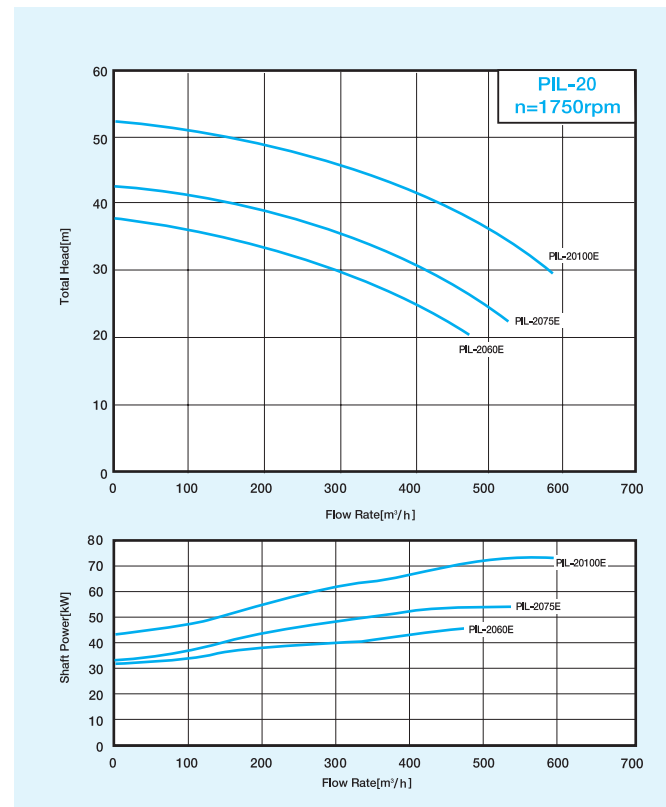

# In-Line Pumps

## PIN Series



Product Introduction



### Design and structure

1. Inline structure : Antivibration pad is not needed.
2. It does not require a huge space for installation, and it is light and handy to assemble/disassemble.
3. Low vibration and noise as pumps and motor shaft are in one unit.

### Application

- Hot water circulation of the building
- Hot water circulation of townhouse
- Agricultural fluid.
- Max. allowed working pressure: 3kgf/cm<sup>2</sup>
- Max. allowed working temperature: 0-80°C

### Products specification

MODEL	Bores(mm)		Motor rating (HP)	Flow rate (m³/h)	Head (m)	Total weight (kg)
	Suction	Discharge				
PIN - 4001	40	40	1	7.2	10	34
PIN - 5001	50	50	1	7.2	10	34
PIN - 5002	50	50	2	14.4	10	47
PIN - 6502	65	65	2	14.4	10	47
PIN - 6503	65	65	3	30	10	71
PIN - 8003	80	80	3	30	10	71

Bore size shown above is based on size of counter flange.

### Outline Dimensions

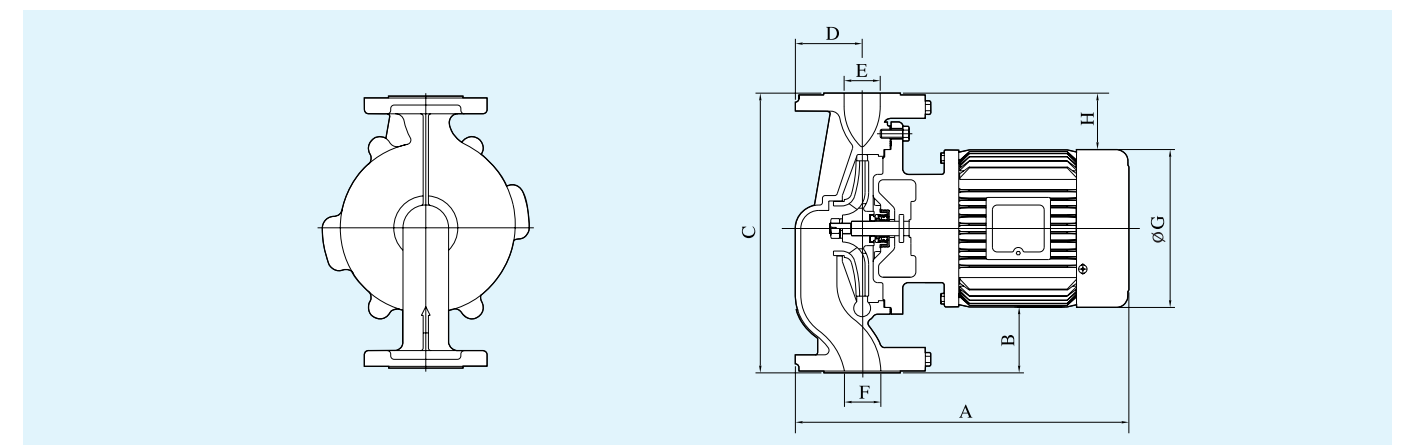

MODEL	PHASE	OUTPUT	A	B	C	D	E	F	øG	H	Fr. No
PIN-4001/5001	3	0.75kW	371	72.5	310	76	ø 40	ø 40	175	62.5	80M
PIN-5002/6502		1.5kW	431	74	330	77.5	ø 50	ø 50	192	64	90M
PIN-6503/8003		2.2kW	464	72.5	380	87.5	ø 65	ø 65	235	72.5	112M





# In-Line Pumps

## PIN Series

Performance curve

PIN- 4001/5001

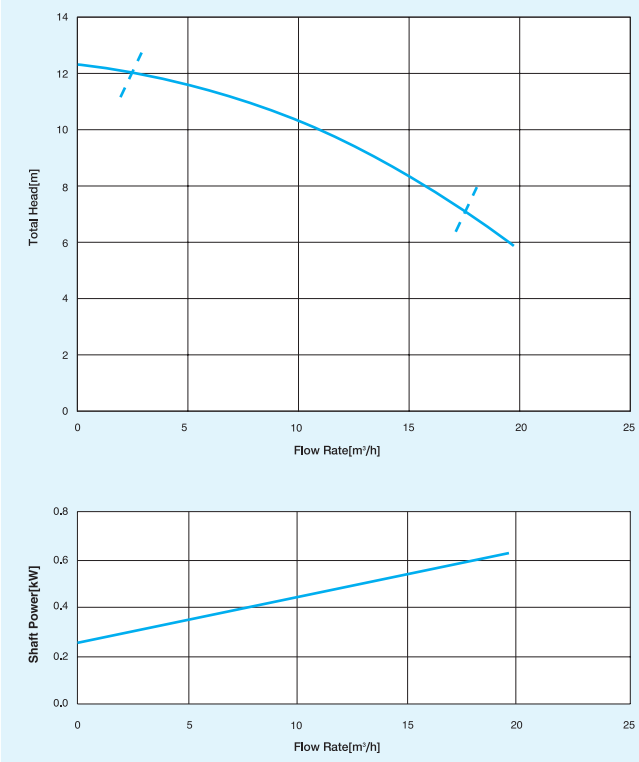

PIN-5002/6502

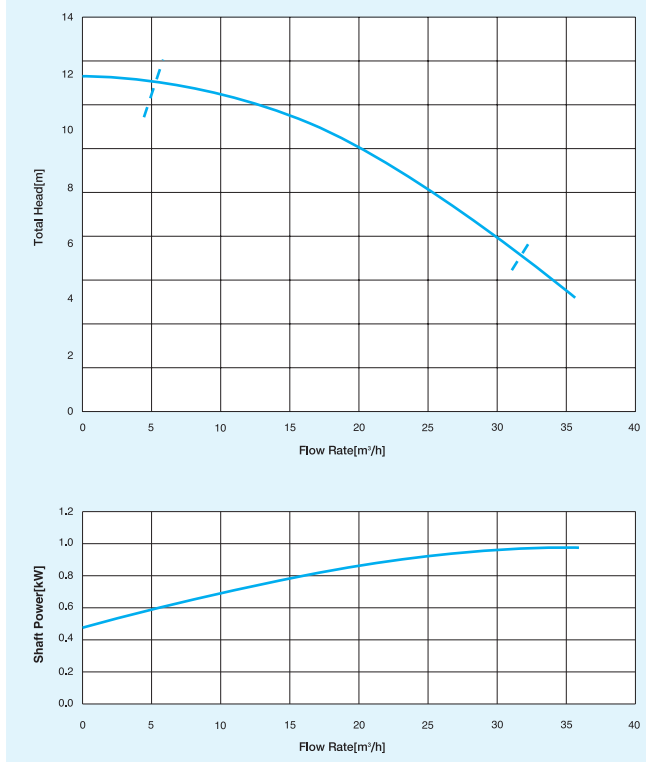

PIN-6503/8003

